



ARRIFLEX 435

Instruction Manual

As of: March 1996

ALL ARTWORK, PICTURES AND TEXTS ARE COVERED BY OUR COPY-RIGHT.

THEY MUST NOT BE COPIED FOR REPRODUCTION (E.G. ON CD-ROM DISKS OR INTERNET-SITES) OR USED IN THEIR ENTIRE FORM OR IN EXCERPTS WITHOUT OUR PREVIOUS WRITTEN AGREEMENT.

IF YOU ARE DOWNLOADING PDF-FILES FROM OUR INTERNET HOME-PAGE FOR YOUR PERSONAL USE, MAKE SURE TO CHECK FOR UPDATED VERSIONS.

WE CANNOT TAKE ANY LIABILITY WHATSOEVER FOR DOWNLOADED FILES, AS TECHNICAL DATA ARE SUBJECT TO CHANGE WITHOUT NOTICE.

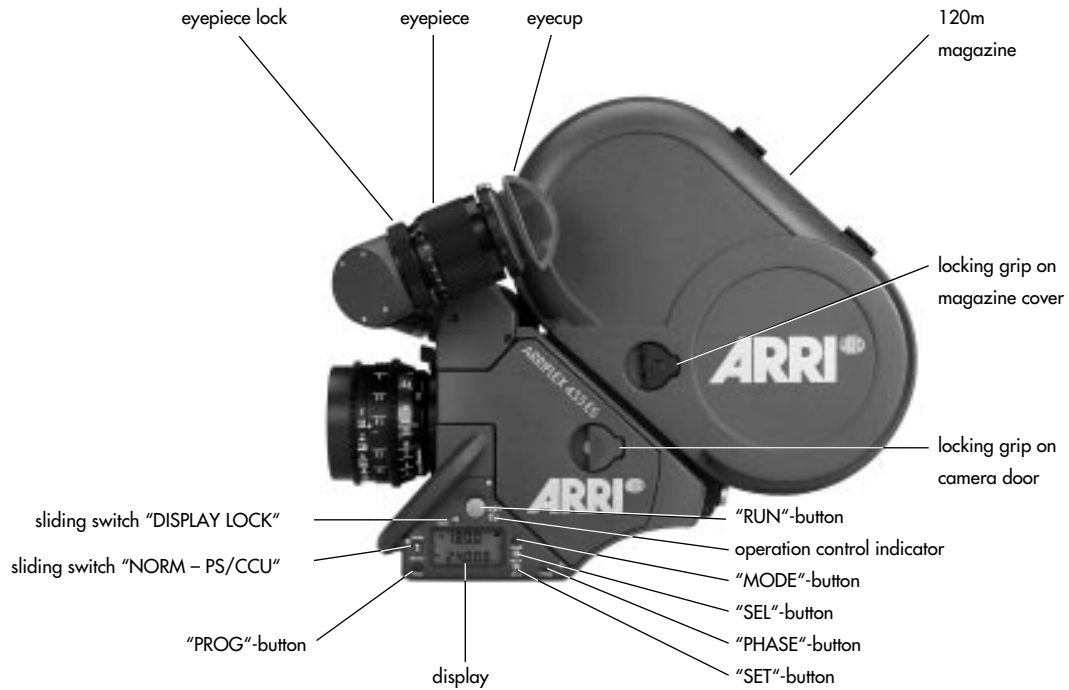

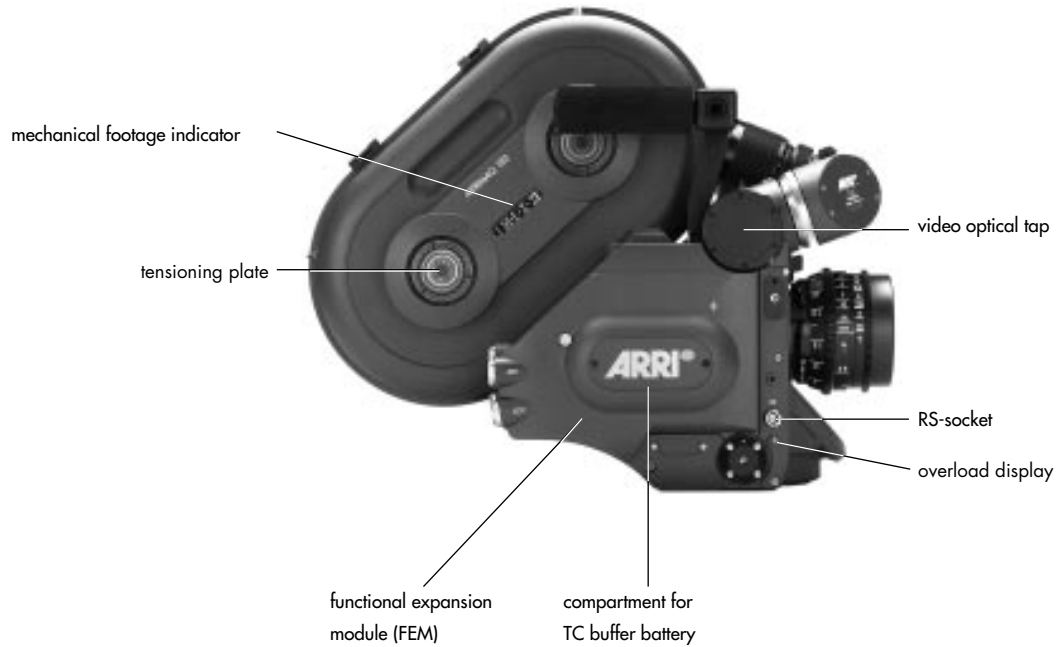

adjustment knob for
manual image
compensation

friction adjustment
finder arm

lock for telescoping
finder arm

locking key for
manual image
compensation

finder arm

ground glass

adjustable
mirror shutter

PL mount

unlocking key for
finder arm

spirit level

hook for tape focus

grip system

11-pin
accessory socket

overload display
for 11-pin
accessory socket

functional expansion
module FEM

ACC-socket

CCU-socket

cover on
magazine opening

main camera switch

power supply
socket

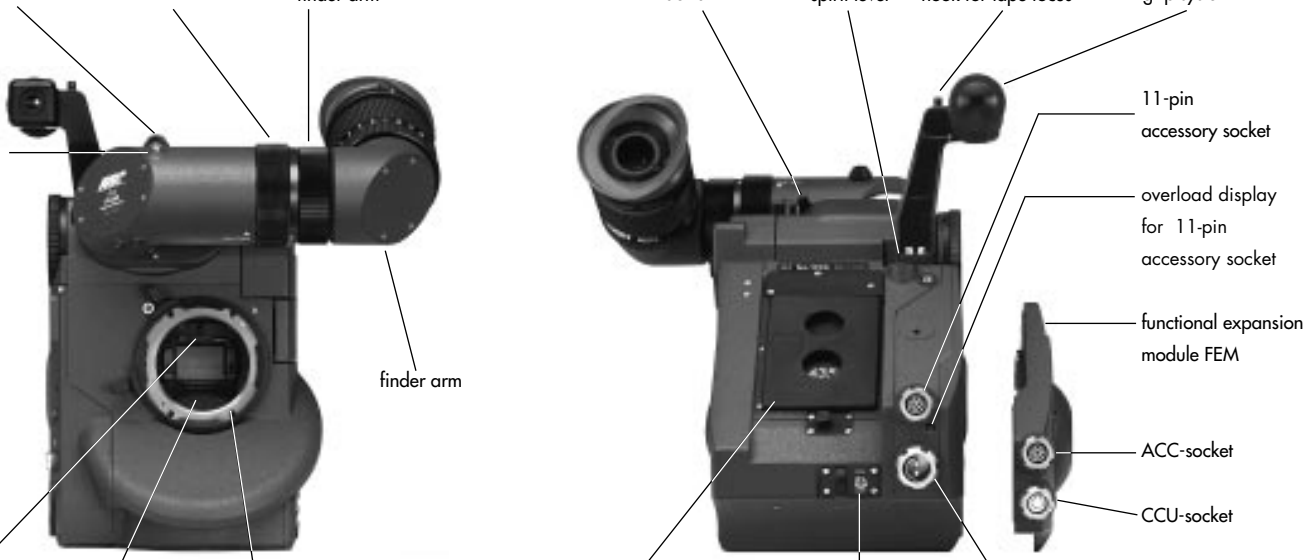

Safety Specifications

Warnings

Note: Operational error possible!



Danger of injury or equipment damage possible!

General Safety Specifications



Attention! Danger of injury! Never place your hand in the lens mount receptacle or the inside of the camera while it is running.

- In order to ensure optimal performance, it is essential that you acquaint yourself with this instruction manual.
- Assembly and initial operation should be carried out only by persons who are familiar with the equipment!
- Never run the camera without a lens or a protective cap in the lens mount receptacle!

- Never operate the movement locking mechanism while the camera is running!
- Ensure that the camera is stably positioned!
- Remove the battery cable before transport or servicing!
- Repairs should be carried out only by authorized service centers!
- Use only original ARRI replacement parts and accessories!

Important Notes

- In wet weather the normal safety precautions for handling electrical equipment should be taken.
- Avoid operational errors!
- Clean optical surfaces only with a lens brush or a clean lens cloth! In cases of solid dirt moisten a lens cloth with pure alcohol.
- Do not use solvents in cleaning the film gate!
- Do not remove any screws which are secured with paint!

Product Specifications

In the case of enquiries or when ordering parts, please advise camera serial number and model.

Note: This instruction manual applies to the ARRIFLEX 435 as well as to the ARRIFLEX 435ES model. Sections that only apply to one model are indicated as such in the heading.

Explanation of the Symbols in the Instruction Manual

⇒ **photo** indicates objects which are shown in the photographs.

Note:

This product and the accessories recommended by the manufacturer fulfill the specifications of the EU-Guideline 89/336/EWG.

Contents

Safety Specifications	5	3. Power Supply	19
Warnings	5	Battery NC 24/7 R	20
General Safety Specifications	5	Charger NCL 24 R	20
Important Notes	5	CHS-1 (Camera Highspeed Supply Module)	21
Product Specifications	6	Mains Unit NG 12/24 R	21
Explanation of the Symbols in the Instruction Manual	6	Mains Unit NG 12/26 R	22
		Accessory Power Supply	22
1. General Description		4. Magazines	25
of the ARRIFLEX 435/435ES	9	Loading the ARRIMAG 120	26
2. Installation of the Camera	11	Removing Exposed Film	29
Packing and Transport	11	Transport and Storage	30
Tripod Heads	11	5. Camera Body	31
Horizontal Leveling of the Camera	12	Mechanically Adjustable Mirror Shutter	
Bridge Plates BP-8, BP-9	12	ARRIFLEX 435	31
Lens Support	14	Electronically Adjustable Mirror Shutter	
Grip System	15	ARRIFLEX 435ES	34
Operation from the Shoulder	17	Exchanging the Ground Glass	38
		Film Gate	39
		Movement	42
		Attaching the Magazine, Threading the Movement ...	43
		Pitch Adjustment	46
		Removing the Magazine	47

6. Optics	49	10. Super 35	99
Lenses	49	Converting the Lens Mount Receptacle to Super 35	99
Viewfinder System	50	Converting the Bridge Plate to Super 35	100
7. Camera Operation	57	11. Time Code	101
Main Camera Switch	57	Time Code Frame Rates	101
Running and Stopping the Camera	58	Mounting the Time Code Module	102
Displaying and Setting Operational Parameters	59	Checking the Loop Length	103
		Setting Film Sensitivity (TCS-Value)	104
		Time Code Input	106
		Switching On and Off the Time Code Recording	109
		Time Code Output	109
		Time Code and the ESU-1	110
		Time Code Buffer Battery	110
		Overview of the Display Indications in TC Operation .	112
8. Video-Assist-System	69	12. Maintenance	115
Mounting the Video-Assist-System	70	Camera	116
Adjusting the Video Optic	72	Cleaning the Spacer Gate	118
		Cleaning the Field Lens	119
		Magazine	120
9. Accessories	75	Appendix	123
Anamorphic Viewfinder AVF-2	75	Technical Data	127
Video Viewfinder VT-2	77	Order Numbers	129
Work Light WL-3	78		
Heated Eyecup HE-3	79		
Remote Run Switch RS-4	79		
Functional Expansion Module FEM	80		
External Synchronization Unit ESU-1	81		
Camera Control Unit CCU-1	82		
Remote Control Unit RCU-1	95		
Laptop Camera Controller LCC	96		
Accessory Socket Distributor (1 1-pin)	97		
R/S - Socket Distributor (3-pin)	97		
		Index	131

1. General Description of the ARRIFLEX 435/435ES

The ARRIFLEX 435/435ES is a compact, light-weight MOS- and HS-camera. Due to the modular design of the camera, its range of functions can be individually expanded. The following features are already integrated into the basic version of the ARRIFLEX 435/435ES.

- Operational parameters can be set directly on the camera.
- The frame rates range from 1 – 150 fps for forward or reverse running.
- The ARRIFLEX 435/435ES is equipped with a low-maintenance, 5-link movement with dual transport claws and registration pins.
- The angle of the mirror shutter can be adjusted mechanically from 11.2° to 180° in fixed stops on the ARRIFLEX 435 when the camera is not running.
The electronic mirror shutter on the ARRIFLEX 435ES can be set continuously from 11.2° to 180° while the camera is running.

- The viewfinder can be rotated in two axes and can be used on both sides of the camera with full image compensation.
- Via an integrated optical tap, a 1/2" CCD video camera can be attached.
- The versatile grip system is connected directly to the camera body and can be used as a carrying handle or as an accessory holder.

A comprehensive range of optical, mechanical and electronic accessories further expands the operational possibilities of the camera.

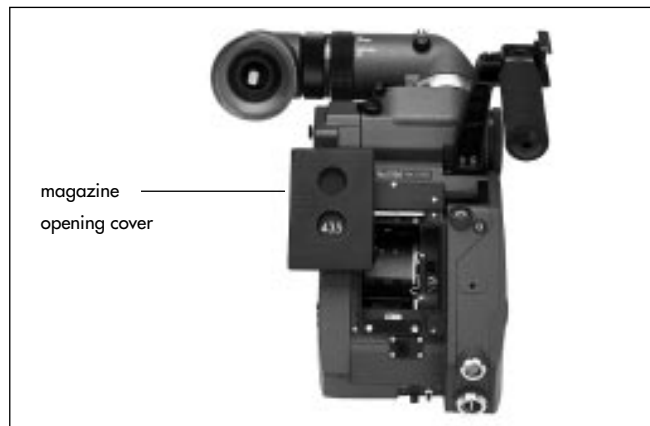

2. Installation of the Camera

Packing and Transport



In order to prevent damage to the mirror shutter, a protective cap must be on the lens mount receptacle at all times.

*When transporting the camera, pay attention that the movement is in the locked position ⇨ **photo**.*

*If the ARRIFLEX 435/435ES is transported or stored without a magazine, the magazine opening cover ⇨ **photo** should be attached.*

*Loaded or empty magazines should only be transported or stored with the loop protector ⇨ **photo** attached to avoid damage to the film stock and the magazine throat assembly.*

Tripod Heads

The following tripod heads are suitable for use with the 435/435ES:

- ARRIHEAD
- ARRIHEAD 2
- ARRI Fluid-Heads
- Sachtler Studio 7, 150 H
- Mitchell-Head
- Moy-Head
- Ronford F7
- Hot-Head
- Cam-Remote-Head
- Worall-Head



In applications where the camera mount is subject to high forces (e.g. helicopter mounts) the camera must be additionally secured with retaining cords. All fastening screws must be tightened firmly with an appropriate screwdriver (not with the commonly used coin!).

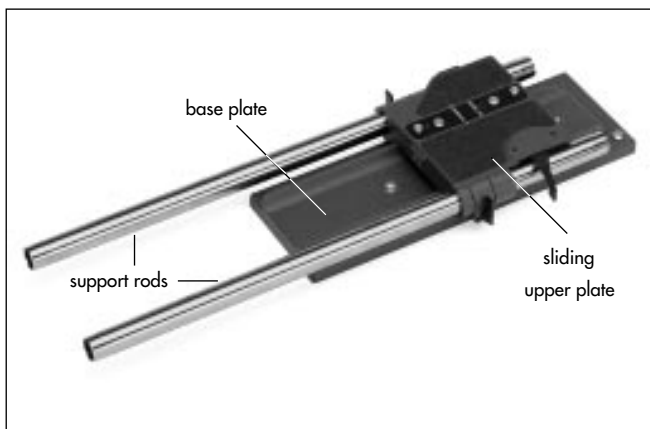
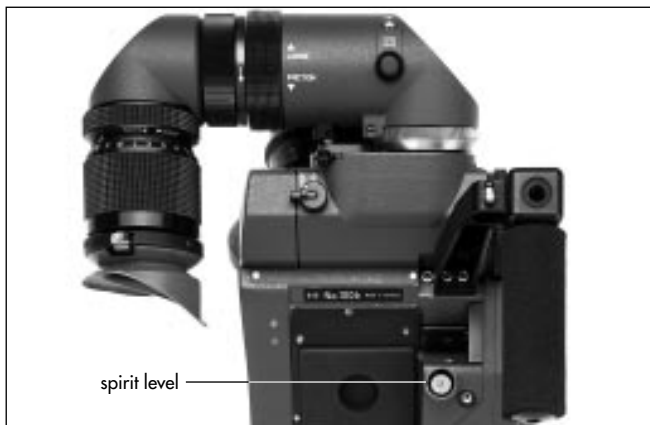

Horizontal Leveling of the Camera

The ARRIFLEX 435/435ES is equipped with a spirit level to aid horizontal leveling of the camera ⇨ **photo**.



If the camera is set on a level surface with the magazine in place, the camera may tip back, as the center of gravity is located far to the rear.

Bridge Plates BP-8, BP-9

The bridge plates facilitate balancing of the camera on the tripod and mounting of accessories. The BP-8 is designed for 19 mm support rods, the BP-9 for 15 mm support rods. The bridge plates consist of the base plate ⇨ **photo**, the sliding upper plate ⇨ **photo** and a pair of support rods ⇨ **photo**. In the standard version the support rods are 440mm long. Optionally, support rods are available in the lengths 240mm and 340mm.

Note: The upper plate of the bridge plate can be converted for use with Super 35. This ensures that the accessories are also exactly adapted to the displaced optical center of the Super 35 format. See also *Chapter 10, Super 35*.

Attaching the Bridge Plate to the Camera

- Fasten the sliding upper plate ⇨ **photo** with the two slit screws to the camera base. Both cylindrical pins ⇨ **photo** (twist prevention) must glide into the holes.
- Then screw the base plate onto the wedge plate of the tripod and lock onto the tripod head.
- Slide the camera with the upper plate into the dovetail-guide of the base plate until the spring-loaded stop pin ⇨ **photo** snaps back audibly. The camera's position can then be fixed with the clamp lever.
- Slide the support rods into the guides and clamp.
- Equip the camera with the required accessories to determine the center of gravity. Loosen the clamping lever ⇨ **photo**, and by sliding the camera on the base plate find the optimal position. Then retighten the clamping lever.

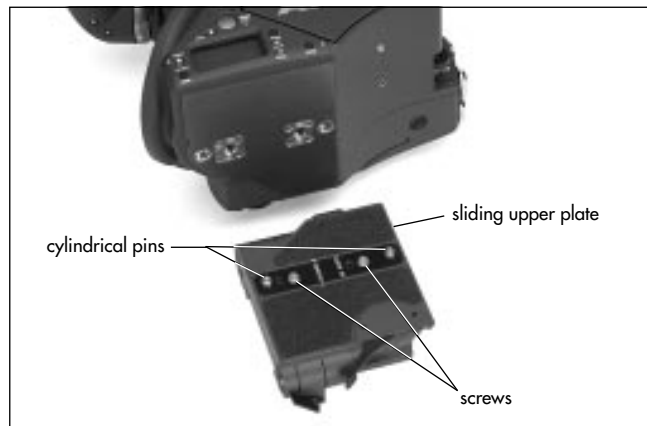

Removing the Camera from the Tripod

- Before removing the camera make sure that all cables are disconnected and that the eyepiece leveling rod is detached.
- For fast removal of the camera from the tripod, loosen the clamping lever ⇨ **photo**, push in the stop pin ⇨ **photo** and then pull the camera with the upper plate ⇨ **photo** from the base plate.

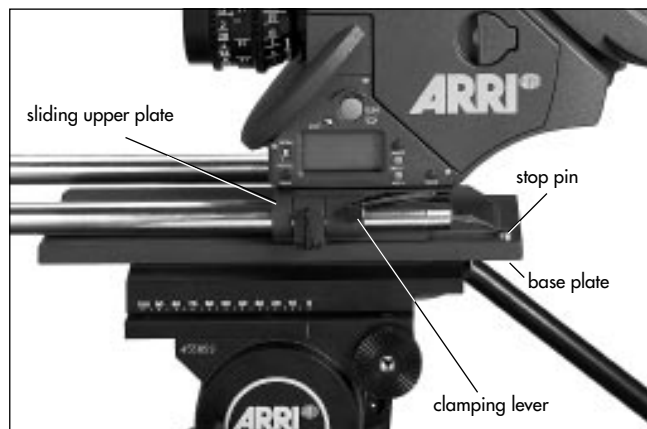

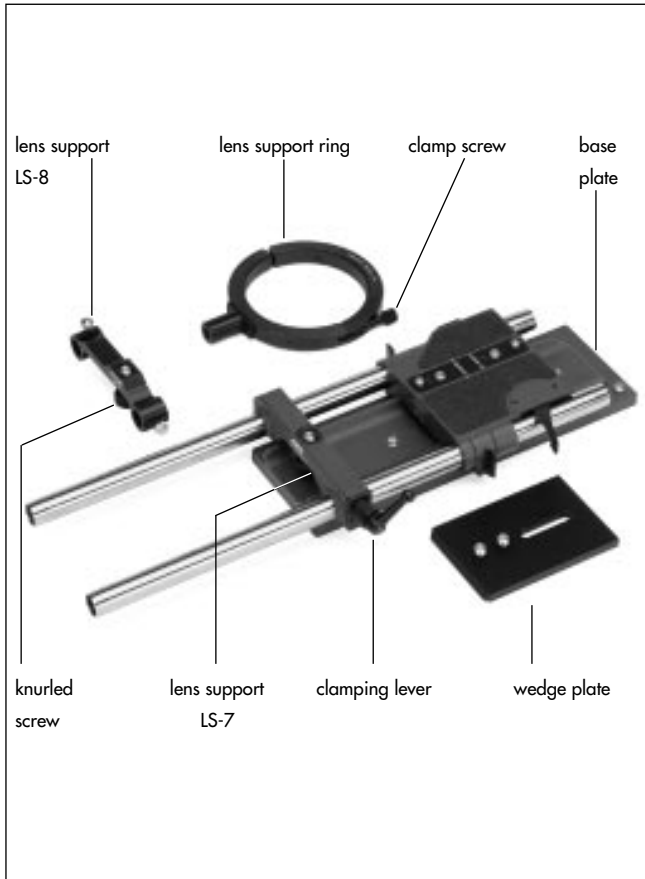

Lens Support

The lens support consists of the lens support LS-7 (can be snapped onto 19 mm support rods) ⇨ **photo** or the lens support LS-8 (can be pushed onto 15 mm support rods) and the respective lens support ring ⇨ **photo** for the lens in use.

- Mount the lens support onto the support rods from above and let it click into place by applying slight pressure (push the LS-8 onto the support rods from the front).
- Slide the relevant support ring ⇨ **photo** onto the lens but do not tighten.
- Then slide the lens into the lens mount receptacle and lock.
- Connect the support ring to the lens support and tighten the knurled screw ⇨ **photo** as well as the clamping lever ⇨ **photo**.
- Complete the process by tightening the clamp screw ⇨ **photo** on the support ring.

Note: Mounting the support ring on the relevant lens is usually carried out only once. The support ring can then remain in position on the lens.

Grip System

The multipurpose grip system on the ARRIFLEX 435/435ES guarantees highest stability through its fixed connection to the camera body and provides numerous possibilities for attaching accessories. Five 3/8" inner threads allow attachment in diverse positions ⇨ **photo**.

Attaching Additional Handgrips

Additional handgrips can be screwed onto the grip system in various positions as required. A safety mechanism in the handgrip prevents automatic loosening. This mechanism is activated by screwing in the handgrips tightly.



Before screwing in the handgrips, make sure that the 3/8" threaded bolt is completely screwed out of the handgrip.

Removing the Grip System

In order to minimize camera height, the entire grip system can be removed.

- First remove the magazine.
- Loosen both the hexagon screws ⇨ **photo** in the strut and pull the grip system ⇨ **photo** upwards.

To attach the grip system, proceed in the reverse order.





Operation from the Shoulder

Shoulder Set S-4

The shoulder set S-4 was designed to optimize shoulder operation of the ARRIFLEX 435/435ES. It allows the camera to be quickly transferred from the tripod onto the operator's shoulder without having to remove the optical accessories.

Shoulder Set S-4 with the Bridge Plate

- Remove the camera from the tripod (see under *Bridge Plates BP-8, BP-9*).
- The mounting screws on the shoulder set must first be screwed back as far as they will go ⇨ **photo**.
- Now slide the shoulder set from the rear into the dovetail-guide on the bridge plate as far as it will go. It locks automatically in position.
- Clamp the shoulder set using the bridge plate clamping lever.
- Plug the cable for starting and stopping the camera into the RS-socket.
- Check that the shoulder set is firmly seated on the camera.
- Position the shoulder cushion on the camera with the index pin and fasten it to the camera with the mounting screw ⇨ **photo**.
- Check that the shoulder cushion is firmly seated on the camera.

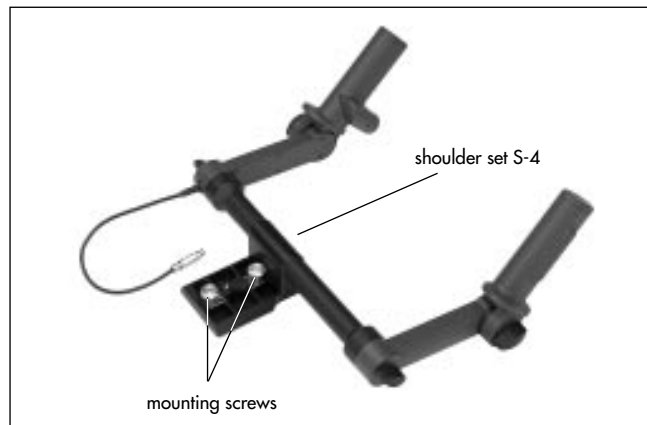

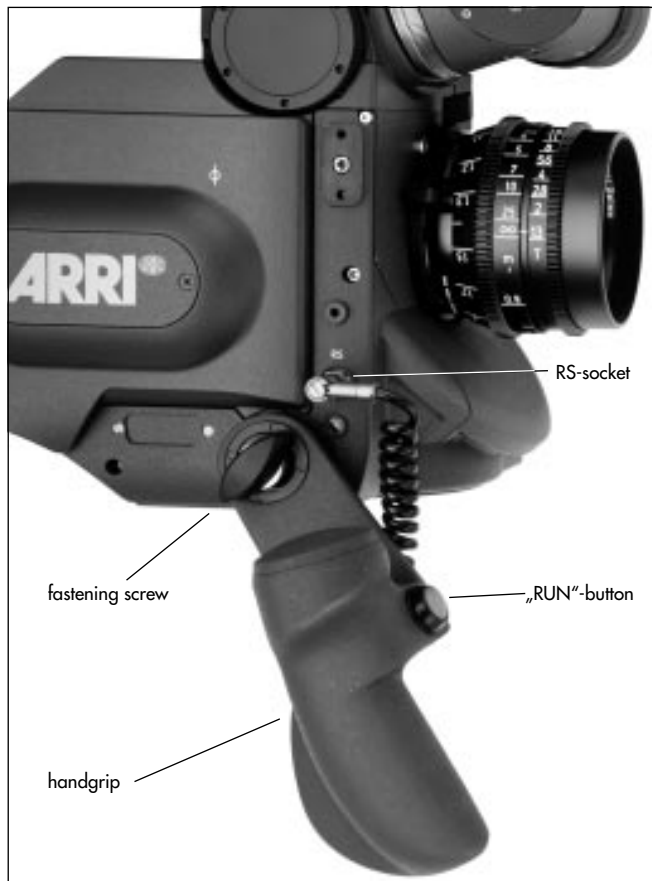

Shoulder Set S-4 without the Bridge Plate

- Remove the camera from the tripod.
- Detach the bridge plate.
- Position the shoulder set on the camera and fasten with the two mounting screws.
- Plug the cable for starting and stopping the camera into the RS-socket.
- Check that the shoulder set is firmly seated on the camera.
- Position the shoulder cushion on the camera with the index pin and fasten it to the camera with the mounting screw.
- Check that the shoulder cushion is firmly seated on the camera.

Operation from the Shoulder without the Shoulder Set

The shoulder cushion can be used with or without the bridge plates BP-8 and BP-9.

- Position the shoulder cushion on the camera with the index pin and fasten it to the camera with the mounting screw.
- Check that the shoulder cushion is firmly seated on the camera.
- Position the handgrip on the rosette and fasten with the fastening screw ⇨ **photo**.
- Plug the cable for starting and stopping the camera into the RS-socket.

3. Power Supply

The acceptable voltage range is from 20.6 to 35 V DC. Depending on the desired frame rate, the following voltage range should be chosen for the power supply:

Frame Rate Range	Voltage
1 - 130 fps	20.6 - 35 V DC
130 - 150 fps	24 - 35 V DC

The power supply cable is attached to the power supply socket on the camera.

Available are:

for 1 - 130 fps

- the battery NC 24/7 R ⇨**photo** with charger NCL 24 R ⇨**photo** and
- the mains unit NG 12/24 R.

for 1 - 150 fps

- two batteries NC 24/7 R ⇨**photo** with charger NCL 24 R, together with the HS power supply module CHS-1 (Camera Highspeed Supply Module) and
- the mains unit NG 12/26 R ⇨**photo**.

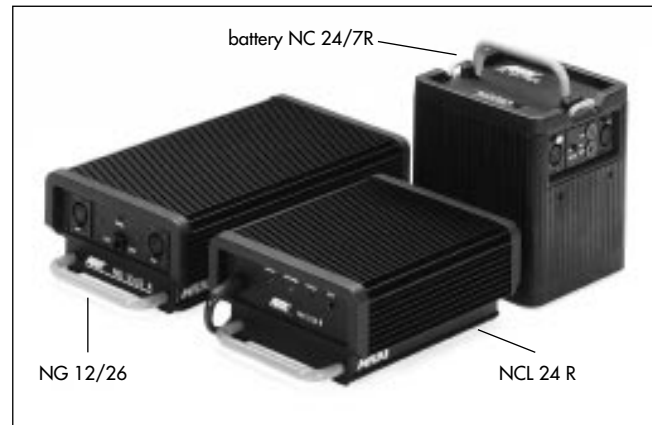

- First switch on the mains unit (if used).
- Connect the camera to the mains unit or to the battery.
- Switch on the main switch of the camera.



*Do not open the batteries!
Charge batteries only with the ARRI chargers!*

Do not bypass the fuse or temperature switch!

*Do not heat NC-batteries!
Do not short-circuit NC-batteries!*

Battery NC 24/7 R

The battery NC 24/7 R has a capacity of 7 ampere-hours and is suitable for frame rates up to 130 fps.

- Ensure that the main switch on the camera is off.
- Plug the battery cable KC 20S or the spiral battery cable KC 29S into the power supply socket on the camera and into the battery-socket.

Note: If the battery voltage is not sufficient for the chosen frame rate, the “bat” symbol will show in the camera display.

Charger NCL 24 R

With this charger all ARRI 24 V batteries can be charged.

- First check whether the correct mains voltage is set on the charger.
- Connect the charger to the mains supply.
- Plug the charger cable into the battery socket.
- Press the start button.

Indication of the LEDs

LED	Indication
yellow	discharging (1A)
red	charging
green	charger connected to the mains

CHS-1 (Camera Highspeed Supply Module)

The CHS-1 connects two 24 V batteries together to provide a HS-power supply with an output voltage of 30 V DC for frame rates up to 150 fps. Connecting the batteries together considerably lowers the camera's current demand.

- Ensure that the main camera switch is off.
- Connect both batteries to the input sockets of the CHS-1 with battery cables KC 20S or spiral cables KC 29S.
- Plug the output cable of the CHS-1 into the camera's power supply socket.

Note: Battery voltages below 20 V are indicated for each battery by a "LOW-BAT"-LED next to the respective input socket of the CHS-1. To prevent over-discharging, the module switches off if either battery voltage drops below 17 V.

Mains Unit NG 12/24 R

Use of the mains unit is recommended for filming in the studio and when using electronic accessories with a high power consumption. It is suitable for frame rates up to 130 fps.

- First check that the correct mains voltage is set on the mains unit.
- Ensure that the main switch on the camera is off.
- Set the voltage switch on the mains unit to 24 V.
- Plug the battery cable KC 20S or the spiral battery cable KC 29S into the power supply socket on the camera and into the 24 V-socket on the mains unit.

Mains Unit NG 12/26 R

Use of the mains unit is recommended for filming in the studio and when using electronic accessories with a high power consumption. It is suitable for frame rates up to 150 fps.

- First check that the correct mains voltage is set on the mains unit.
- Ensure that the main switch on the camera is off.
- Set the voltage switch on the mains unit to 26 V.
- Plug the battery cable KC 20S or the spiral battery cable KC 29S into the power supply socket on the camera and into the 26 V-socket on the mains unit.

Note: The NG 12/24 R can easily be upgraded to an NG 12/26 R at an ARRI service center.

Accessory Power Supply

12 V Accessories

12 V accessories can be attached to the 11-pin accessory socket  which provides stabilized 12 V DC with 3 A maximum continuous current and 5 A peak load.

Note: The 11-pin accessory socket can only be used as an output socket. Accessories that feed signals into the camera will not function at this socket.



24 V Accessories



The RS-socket supplies the same voltage as the camera power supply. Voltages over 32 V will be limited to 32 V. In this case, the allowable continuous current is 2 A maximum. Ensure that the accessories to be used are suited to the available voltage!

24 V accessories are normally attached to the RS-socket . At 24 V, the available continuous current is 3 A maximum, the peak load 5 A.

Overload Display

If the current drawn at the accessory sockets exceeds the allowable maximum, a safety circuit interrupts the power supply and a red warning LED lights up .





4. Magazines

In addition to the new 435-ARRIMAG magazines → **photo**, all ARRIFLEX 35 III and 35 II magazines – with the exception of the shoulder magazine – can be used.



Reverse operation with the ARRIFLEX 35 III / 35 II 300 m and 60 m magazines can lead to damage of the magazine or the camera!

Time code can only be recorded with the new ARRIMAG magazines.

Magazine	Speed limit	Forward/Reverse operation	TC-Recording
ARRIFLEX 435			
ARRIMAG 120	150 fps	forw./rev.	yes
ARRIMAG 120S	150 fps	forw./rev.	yes
ARRIMAG 300E	150 fps	forw./rev.	yes
ARRIFLEX 35 III / 35 II			
60 m magazine	130 fps	only forwards	no
150 m magazine	130 fps	forw./rev.	no
300 m magazine	130 fps	only forwards	no

The ARRIMAG magazines and the ARRIFLEX III magazines are automatically recognized. For the ARRIFLEX 35 III 300 m magazine the camera's run-up time is automatically extended. If the camera is set to a frame rate that exceeds the speed limit of the attached magazine, the "fps"-symbol flashes on the camera display and the camera will not run. If the frame rate is adjusted above the magazine speed limit during running, the camera's speed will be limited to 130 fps. The frame rate must be reset.

Note: All magazines listed above are loaded with the same loop length as on the ARRIFLEX 35 III. The loading of ARRIFLEX 35 III magazines is described in the respective instruction manuals.

Loading the ARRIMAG 120

Loading the magazine should be practised in daylight with a piece of test film until the procedure can also be carried out confidently in a darkroom or film changing bag. Cutting the film through the middle of the perforation holes simplifies the loading process considerably. The ARRI Film Cutting Gauge ⇨ **photo** simplifies cutting in the darkroom.

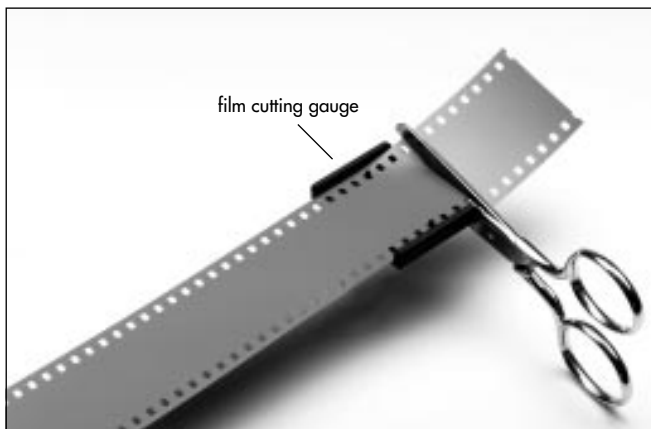

The following steps should be carried out in a darkroom or film changing bag!

- Remove the loop protector and lay the magazine on a flat surface with its cover facing upwards.
- To open the cover, depress the safety catch, flip up the flag-hinged locking grip and turn it counter-clockwise ⇨ **photo**.
- Flip up the magazine cover.
- Swing both roller arms ⇨ **photo** away from the winding shafts until they lock in place.
- Place the film roll next to the magazine.

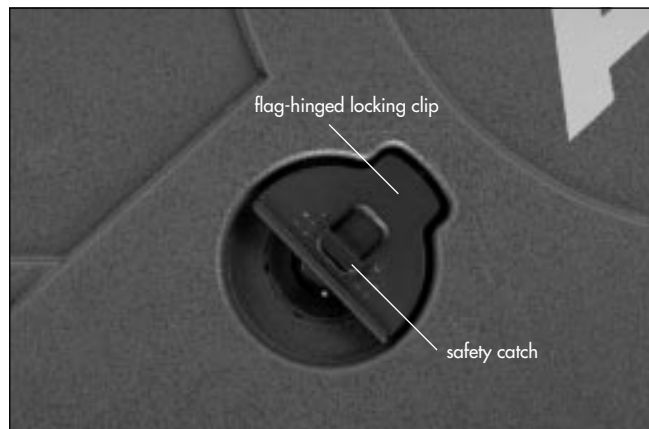

- Insert the film through the left slit on the magazine throat assembly from the inside ⇨ **photo**.
Do not catch the film.
- With your free hand, turn the drive gear counter-clockwise while carefully pushing the film through until both perforation holes are picked up simultaneously by the sprockets.
- Keep turning the gear until the film has been transported through the throat assembly.
- Flip up the hinged locking clip on the feed shaft ⇨ **photo**.
- Place the film roll on the feed shaft, ensuring that the feed shaft catch engages the slot on the plastic core.
- Press down the hinged locking clip on the feed shaft.
- By turning the drive gear counter-clockwise, transport the film further until it reaches to the loop length marking ⇨ **photo**.



Ensure that the film is lying flat against the outside of the magazine housing.

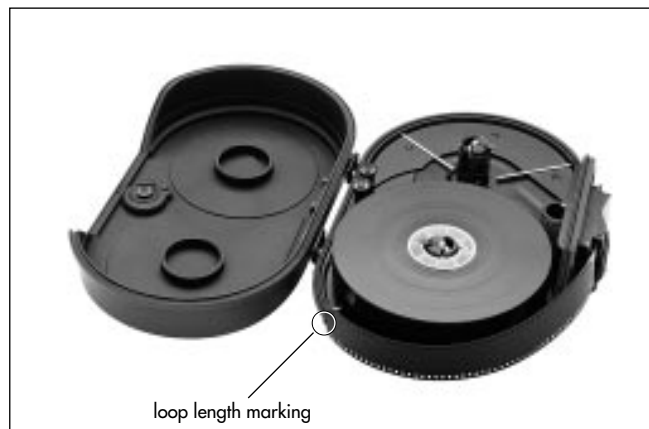
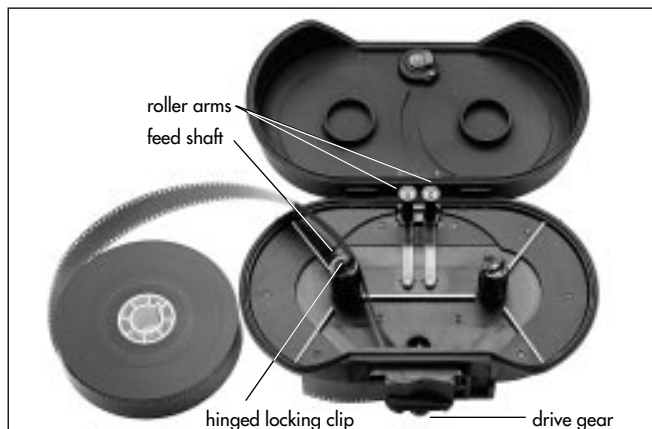

- Without changing the length, thread the film into the right film channel.
Do not catch the film.
- By again turning the drive gear counter-clockwise, transport the film inside the magazine.
- Flip up the hinged locking clip on the take-up shaft
⇒ **photo**.
- Place an empty film core on the take-up shaft. The slit must point in the direction of operation. Ensure that the take-up shaft catch engages the slot on the plastic core.
- Press down the hinged locking clip on the take-up shaft.

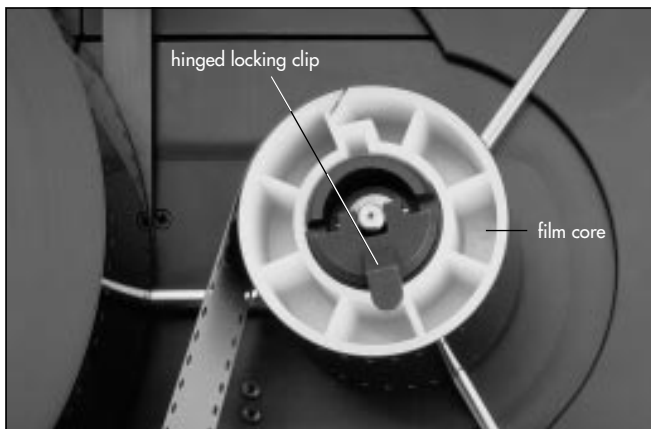

- Hang the head of the film into the film core and bend over ⇒ **photo**.
The bent film head should not stick out of the film core as this could cause unbalance.

Note: If the film head has been bent over, the film head must not be pulled through the throat assembly during reverse operation.

- Wind the film on at least one revolution until it is certain that the film is firmly seated on the film core.
- Check that the film is being taken up perpendicular to the shaft ⇒ **photo**.



- Close the magazine cover. The roller arms will be automatically unlocked.
- To lock the cover, turn the locking grip clockwise and flip it back into the recess.
The safety catch locks automatically.

Note: To tension the film in the magazine, press in both tensioning plates ⇨ **photo** and turn outwards.



Removing Exposed Film

The following steps should be carried out in a darkroom or a changing bag!

- Check if the entire film has been wound into the interior of the magazine. If not, transport the film into the magazine by turning the drive gear counter-clockwise.
- To open the cover, depress the safety catch and flip the locking grip upwards. Then turn the grip counter-clockwise.
- Flip up the cover.
- Swing both roller arms ⇨ **photo** away from the winding shafts until they lock in place.
- Flip up the hinged locking clip on the take-up shaft.
- Pull the film roll upwards and off.

Note: When pulling the film roll off the shaft, grip it from underneath as far as possible to prevent the middle of the film roll from sagging down.



The film should under no circumstances be pulled tight. This could cause scratches and static charging.

Transport and Storage

Loaded or empty magazines should only be transported or stored with the loop protector ⇨ **photo** attached to avoid damage to the film stock and the magazine throat assembly.

If the ARRIFLEX 435/435ES is transported without a magazine it is recommended to attach the magazine opening cover.

Note: The cover must be attached to the ARRIFLEX 435/435ES to run frame rates above 130 fps without a magazine for testing purposes.



5. Camera Body

Mechanically Adjustable Mirror Shutter ARRIFLEX 435

The mirror shutter can be adjusted mechanically while the camera is switched off. The shutter angle can be adjusted from 11.2° to 180°. The shutter locks in the following positions: 11.2°, 22.5°, 30°, 45°, 60°, 75°, 90°, 105°, 120°, 135°, 144°, 172.8° and 180°.

Setting the Mirror Shutter Angle

- By briefly depressing the "PHASE"-button, the mirror shutter is positioned to allow access to the shutter angle adjusting mechanism ⇨ **photo** and the locking mechanism ⇨ **photo**.
- Switch off the camera and disconnect the camera from the power supply!
- Remove the lens or the protective cap from the lens mount receptacle.





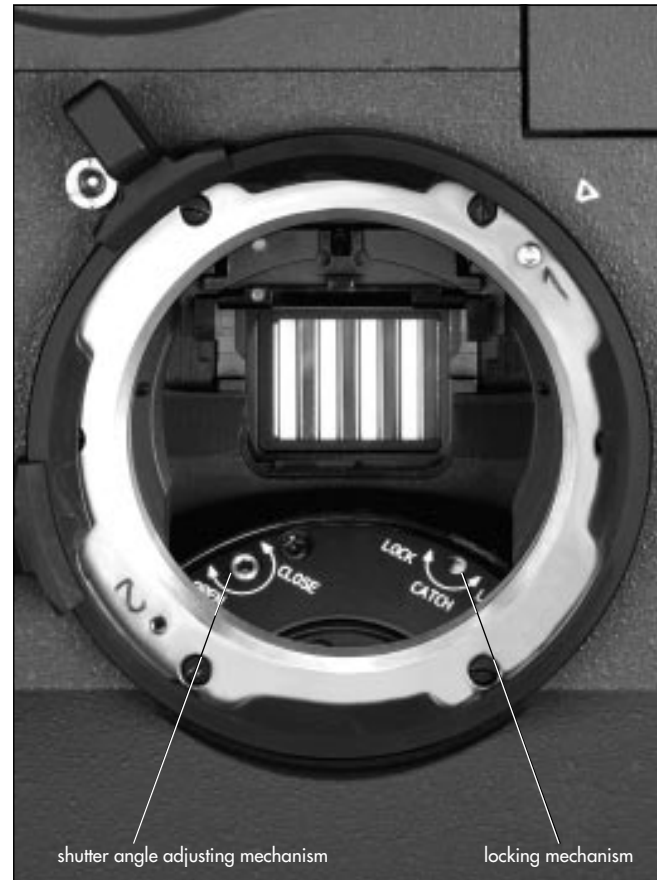

Do not touch the surface of the mirror!

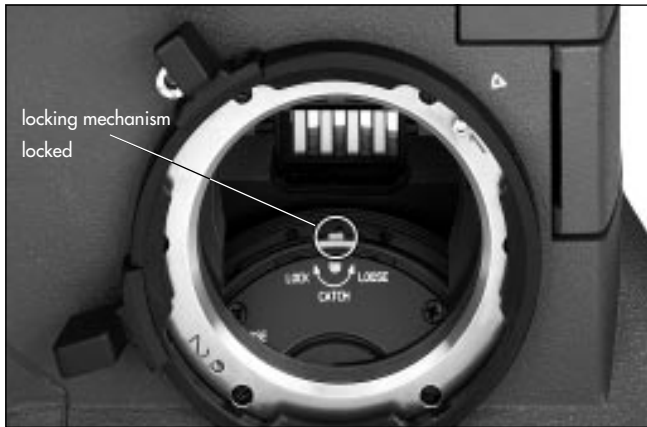
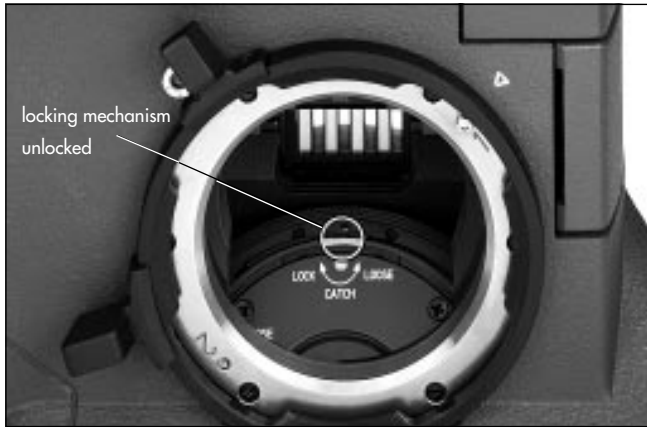

shutter angle adjusting mechanism

locking mechanism



- With a 2 mm Allen key turn the locking mechanism  towards the “LOOSE” position until it stops.
- Turn the shutter angle adjusting mechanism  with the same Allen key until the desired shutter angle is reached.
- Turn the locking mechanism  towards the “LOCK” position until this locks in place. The adjusting mechanism may possibly have to be turned slightly back and forth.
- By gently twisting the shutter angle adjusting mechanism, check if the shutter angle has locked in correctly.



Operation of the camera when the mirror shutter is not correctly locked in position may cause incorrect exposure!

With an unlocked mirror shutter, the camera may switch off during camera run!

Shutter Angle Measurement

- Holding the "PHASE"-button depressed in standby will make the camera inch forward.
- The display shows the measured shutter angle in the upper line. The lower line displays the voltage of the power supply.



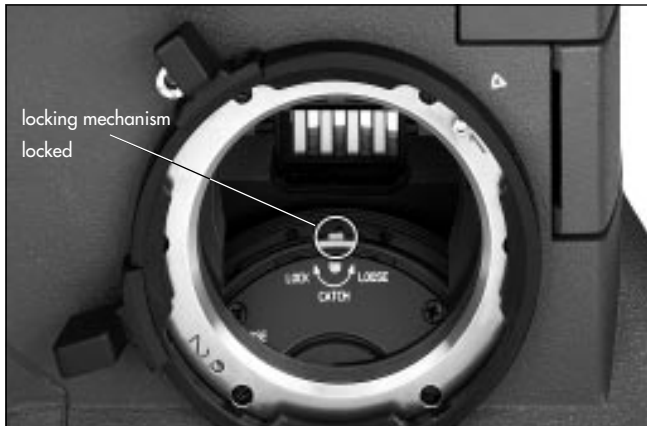
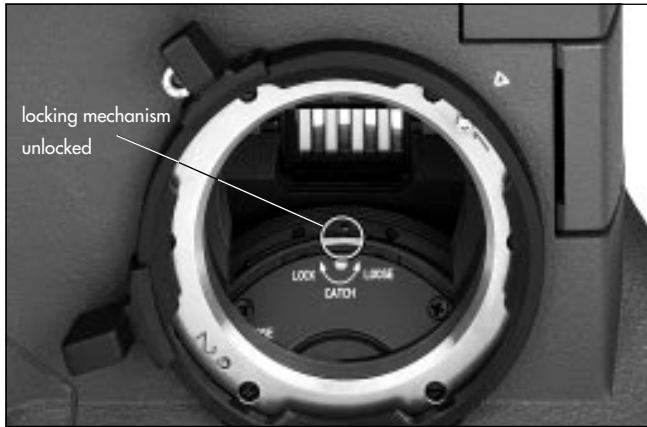

Electronically Adjustable Mirror Shutter ARRIFLEX 435ES

The mirror shutter on the ARRIFLEX 435ES can be electronically adjusted from 11.2° to 180° when the camera is running as well as in standby.

Note: The electronically adjustable mirror shutter is also equipped with an adjustment mechanism that allows mechanical adjustment. The electronic mirror shutter function must then be switched off.



*Before electronically adjusting the mirror shutter, check that the shutter locking mechanism is in the "LOOSE" position ⇨ **photo**. Adjusting the shutter angle while the shutter is locked could cause damage to the camera!*

Checking the Shutter Locking Mechanism

- Switch on the camera's main switch.
- In standby, briefly depress the "PHASE"-button.
- Switch off the camera's main switch.
- Remove the lens or the protective cap from the lens mount receptacle.



Never put your fingers into the lens mount receptacle.

- The locking mechanism should be in the unlocked position ⇨ **photo**.

If the shutter locking mechanism is unlocked

- Replace the lens or the protective cover.

If the shutter is locked in position

- Disconnect the camera from the power supply.
- With a 2 mm Allen key turn the locking mechanism ⇨ **photo** towards the "LOOSE" position until it stops.
- Replace the lens or the protective cover.

Setting the Mirror Shutter Angles:

Without accessories, the following shutter angles can be set directly on the camera: 11.2°, 22.5°, 30°, 45°, 60°, 75°, 90°, 105°, 120°, 135°, 144°, 172.8° and 180°.

With accessories such as the LCC, CCU or RCU-1 other shutter angles can be set. The procedure is described in the respective instruction manuals.



Adjusting the shutter angle when the shutter is locked could cause damage to the camera! Ensure that the locking mechanism is in "LOOSE" position before adjusting the shutter angle.

- Switch on the camera's main switch.
- Change to Mode 7 by depressing the "MODE"-button six times (or four times if no functional expansion module is attached). The display shows the angle symbol and, in the upper line, the current shutter angle.



If the display shows "OFF", the electronic adjustment of the mirror shutter is deactivated. The shutter angle can be adjusted mechanically and must then be locked. See the section "Mechanically Adjustable Mirror Shutter".

- Depress the "SEL"-button repeatedly until the desired value blinks in the display. With the "SET"-button confirm the desired shutter angle.

Shutter Angle Measurement

- Holding the "PHASE"-button depressed in standby will make the camera inch forward.
- The display shows the measured shutter angle in the upper line. The lower line displays the voltage of the power supply.



Switching Off the Electronically Adjustable Shutter

- Switch on the camera's main switch.
- Change to Mode 7 by depressing the "MODE"-button six times (or four times if no functional expansion module is attached). The display shows the angle symbol and, in the upper line, the current shutter angle.
- Depress the "SEL"-button repeatedly until the display shows "OFF". With the "SET"-button, confirm switching off the electronic angle adjustment.



As the electronic shutter has been switched off, the shutter angle must now be adjusted and locked manually! See the section "Mechanically Adjustable Mirror Shutter".

Note: As a warning that the electronic shutter has been switched off, the angle symbol in the camera display blinks in all modes.

Switching On the Electronically Adjustable Shutter



Switching on the electronically adjustable shutter when the shutter is locked can cause damage to the camera! See "Checking the Shutter Locking Mechanism".

- Before switching on, ensure that the shutter locking mechanism is in "LOOSE" position.
- Switch on the camera's main switch.
- Change into Mode 7 by depressing the "MODE"-button six times (or four times if no functional expansion module is attached). The display shows the angle symbol and "OFF" in the upper line.
- Depress the "SEL"-button repeatedly until the display shows the desired shutter angle. The "SET"-button confirms the entry and activates the electronic shutter adjustment.

Filming with HMI Light

When lighting scenes with HMI/CID-discharge lamps, the pulsing light intensity is dependent on the supply frequency.

To achieve constant exposure, the camera's frame rate, the supply frequency of the lighting and the angle of the mirror shutter must all relate to each other. As the camera frame rate and the supply frequency of the lighting are normally given, compensation must be carried out through the angle of the mirror shutter.

The following table indicates the mirror shutter angle that needs to be set:

Supply frequency	50 Hz		60 Hz
Frame rate	25 fps	24 fps	24 fps
Shutter angle	180 °	172.8 °	144 °

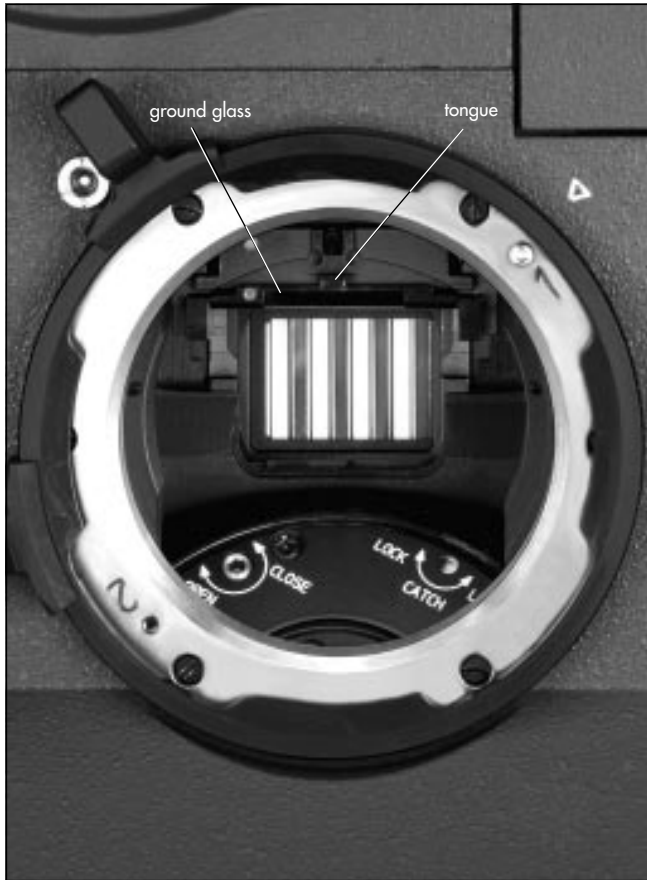

Exchanging the Ground Glass

- By briefly depressing the “PHASE”-button in standby, the shutter is positioned to protect the mirror surface from damage as far as possible **photo**.
- Before exchanging the ground glass, switch the camera’s main switch off and disconnect the camera from the power supply!
- Remove the lens or the protective cap.



Do not touch the mirror surface!

- Using the included special forceps, pull the ground glass **photo** out of the holder by its tongue **photo**.
- Check that the ground glass to be inserted as well as the ground glass frame are completely clean.
- With the special forceps, push the chosen ground glass into the holder as far as it will go. The red marker point must be on the left. A ball catch fixes the ground glass exactly in the right position.
- Check that the ground glass is correctly locked in place.

Note: Cleaning or exchanging the field lens, see *Chapter 11, Cleaning the Field Lens.*

Film Gate

Changing the Format Masks

A format mask and filter holder must always be inserted in the film gate.

To take out the format mask:

- Switch off the camera's main switch and disconnect the camera from the power supply before exchanging the format mask.
- Turn the knurled knob **photo** on the movement until its marking matches that on the movement block.
- Turn the movement locking lever **photo** towards the "OPEN" position to swing the movement block away from the film gate.
- Press the film gate locking lever **photo** towards the magazine throat assembly and swing the film gate **photo** towards the movement block, pressing lightly on the lower end of the film gate and taking care that the film gate does not hit the movement block.
- Take hold of the film gate by the filter holder **photo**, lift it up and remove.
- Now pull the filter holder **photo** sideways out of the film gate.
- Press the format mask **photo** lightly on its side flap towards the film gate and then pull this out sideways too.

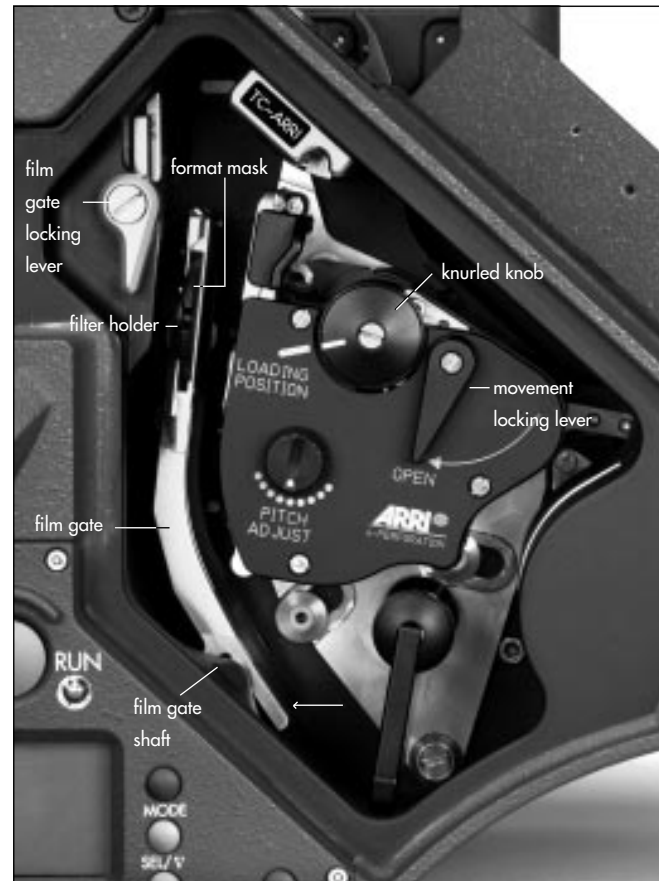

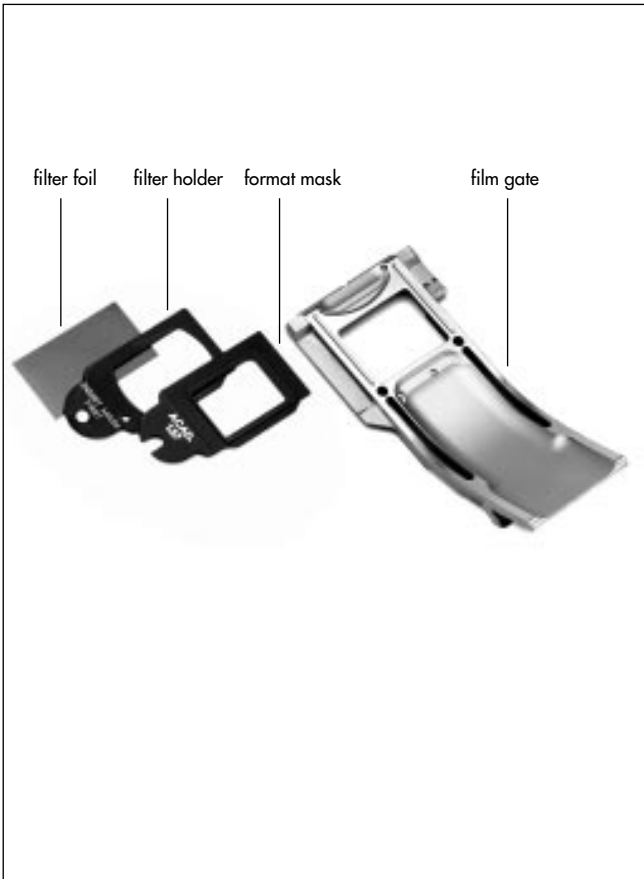

To insert a format mask:

- Check that the film gate frame and the contact surface are absolutely clean.
- Push the new format mask **photo** sideways into the film gate.
- Push the filter holder sideways into the film gate **photo**.
- Check that the film gate and the film gate shaft are completely free of dust and dirt.
- Take hold of the film gate by the filter holder and place onto the film gate shaft from above.
- Check that the film gate is correctly seated on the shaft.
- Press the film gate locking lever towards the magazine throat assembly and push the film gate forwards to the correct position.
- Ensure that the film gate locking lever swings back completely.

Note: The film gate can only be locked if the format mask and the filter holder are correctly inserted.



Swinging the movement block forwards when the film gate is not correctly in place can cause damage to the camera!

Inserting Filters into the Film Gate

Filter foils such as gelatine filters can be inserted into the filter holder.



The camera display does not show a warning when a filter is in use.

- Switch off the camera's main switch and disconnect the camera from the power supply before inserting a filter.
- Turn the knurled knob ⇨ **photo** (p. 5.9) on the movement until its marking matches that on the movement block.
- Turn the movement locking lever ⇨ **photo** towards the "OPEN" position to swing the movement block away from the film gate.
- Press the film gate locking lever ⇨ **photo** towards the magazine throat assembly and swing the film gate ⇨ **photo** towards the movement block, pressing lightly on the lower end of the film gate and taking care that the film gate does not hit the movement block.
- Take hold of the film gate by the filter holder ⇨ **photo**, lift it up and remove.
- Now pull the filter holder ⇨ **photo** sideways out of the film gate.
- Open the filter holder slightly and insert the filter foil ⇨ **photo**. Cut off the jutting edge.
- Check that the film gate frame and the contact surface are absolutely clean.

- Push the filter holder sideways into the film gate ⇨ **photo**.
- Check that the film gate, the filter and the film gate shaft ⇨ **photo** are free of dust and dirt.
- Take hold of the film gate by the filter holder and place onto the film gate shaft from above.
- Check that the film gate is correctly seated on the shaft.
- Press the film gate locking lever ⇨ **photo** towards the magazine throat assembly and push the film gate forwards to the correct position.
- Ensure that the film gate locking lever ⇨ **photo** swings back completely.

Note: The film gate can only be locked if the format mask and the filter holder are correctly inserted.



Swinging the movement block forwards when the film gate is not correctly in place can cause damage to the camera!

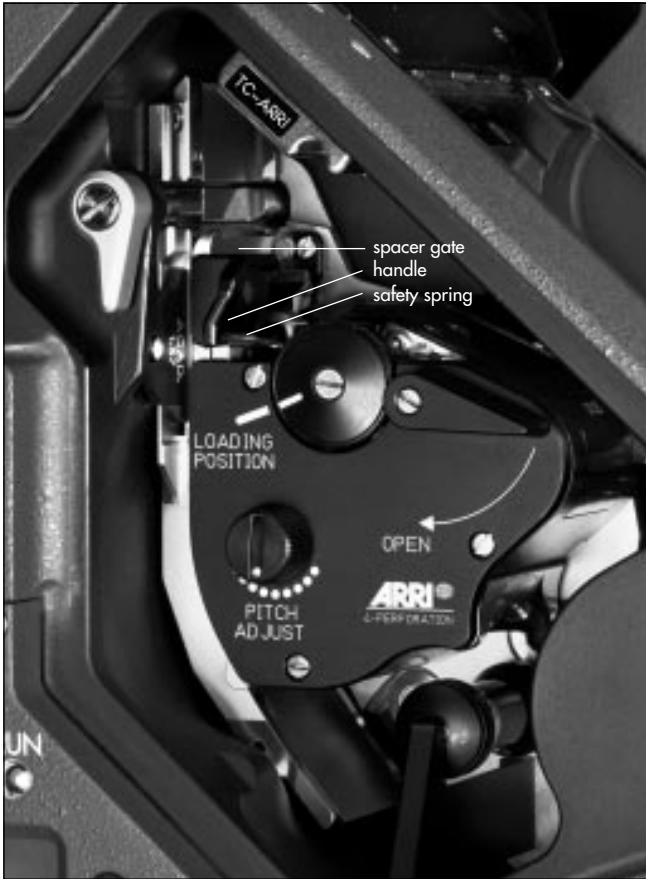

Movement

The ARRIFLEX 435/435ES features a highspeed 5-link movement, equipped with ball-bearings for low maintenance.



Never operate the movement locking mechanism while the camera is running!

Removing the Spacer Gate

- Press the safety spring  downwards, at the same time pressing the spacer gate backwards by its handle . Then remove by pulling upwards.

Installing the Spacer Gate

- Take hold of the spacer gate by its handle  and insert it at an angle from above into the movement block.
- Push the spacer gate downwards until it locks audibly in place.

Attaching the Magazine, Threading the Movement

- Pull the magazine release lever ↔photo back and remove the cover.
- Open the camera door.
- Check that the movement block is swung forwards.
- Remove the loop protector from the magazine.



When attaching the magazine, pay attention that the film does not get caught between the magazine and the dovetail on the camera opening!

- Position the back part of the magazine's throat assembly on the lower dovetail of the camera opening.
- With your left hand pull the film loop through the camera opening as far as possible into the movement block area ↔photo.
- Before locking the magazine into place, ensure that the film is pulled far enough into the movement block area so that the film does not get caught between the magazine and the magazine locking mechanism!



- Lock the magazine completely into the camera opening.

Note: The magazine drive gear engages automatically. Lightly turning the knurled knob on the movement block facilitates the precise engagement of the gear wheel if necessary.



- Check that the magazine is firmly seated.
- With your right hand pull the film loop downwards out of the camera **photo**. Then push it as far upwards as

possible until the loop can be positioned between the movement plate and the film gate.

Note: The film cannot yet be completely placed into the film channel.

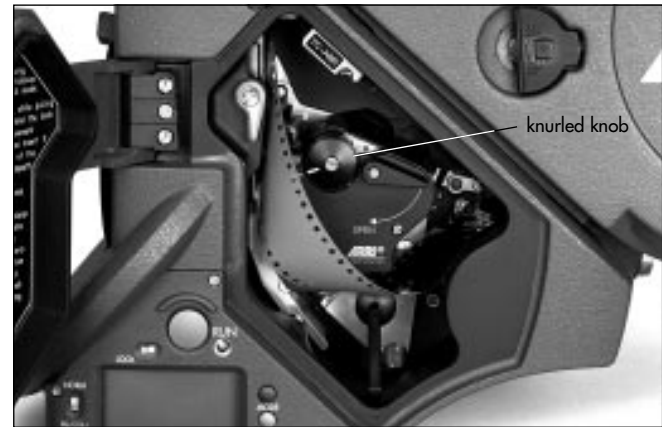
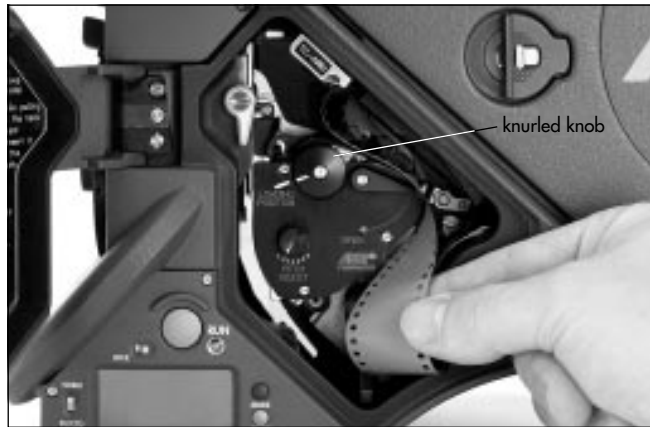
- Turn the knurled knob **photo** on the movement until its marking matches that on the movement block.
- Turn the movement locking lever towards the "OPEN" position to swing the movement block away from the film gate.



- Bring the film loop into position  **photo**.
- Position the film by one perforation hole onto the positioning pin  **photo** in the film guide, bringing the film loop to rest within the marking  **photo**.
- Check that the film is correctly fixed on the positioning pin and that the loop is positioned within the upper marking.

Note: Before the movement block is swung forwards, make sure that the film is correctly positioned in relation to the film gate over entire area, otherwise the film may be damaged!

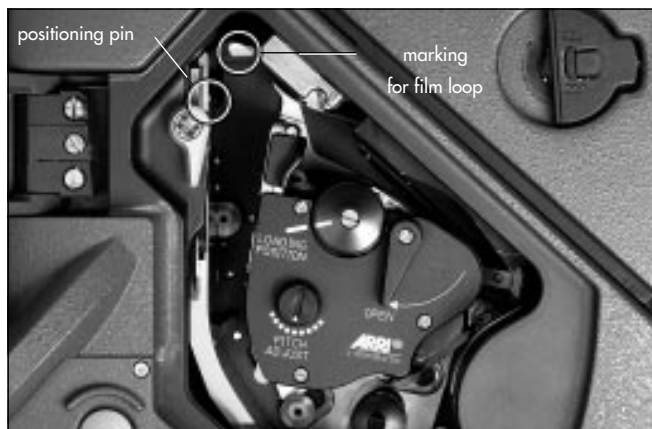

- Turn the movement locking lever counter-clockwise as far as it will go. This will cause the movement block to swing forwards and to lock into position.
- By turning the knurled knob  **photo**, check that the film runs smoothly.
- Turn the knurled knob until its marking matches that on the movement block and again check if the loop is lying within the marking.



If the loop does not lie within the marking the film may be torn and the equipment damaged. In TC operation, the correct recording position in relation to the image will also not be guaranteed.

- Close the camera door.

Note: Threading the movement is described and displayed on the inside of the camera door.



Pitch Adjustment

The camera is delivered with a transport claw pitch adjusted to 4.74 mm (short pitch). With this basic setting, negative film stock having a perforation hole distance within the tolerance range is transported smoothly and reliably by the movement. If the film stock used differs from this perforation distance, the movement can be optimally adapted using the pitch adjustment mechanism.

It is recommended to establish the optimal pitch setting for the film stock in use at a frame rate of 24 fps before beginning filming.

- Attach a loaded magazine and thread the movement.
See "Attaching the Magazine, Threading the Movement".
- Leave the camera door open.
- Run the camera.
- Slowly turn the pitch adjustment **photo** back and forth until the quietest setting is reached.

Removing the Magazine

If the film has not run through the camera completely:

- Open the camera door.
- Swing back the movement block just far enough to enable the film to be pulled out from between the film gate and the movement block.

Note: When slowly swinging back the movement block, a ball catch is noticeable.

- Pull out the film loop sideways from between the movement block and the film gate.
- Bring the loop into the area between the movement block and the magazine throat assembly .



Ensure that the loop does not get twisted behind the movement block as otherwise the film could be damaged when removing the magazine!

- Swing the movement block forwards again and lock.
- Hold the magazine firmly with one hand and pull the magazine locking lever back with the other.



When pulling away the magazine ensure that the film does not get damaged!

- Pull the magazine off upwards.
- Replace the cover on the camera opening.

If the entire film has run through the camera:

- Hold the magazine firmly with one hand and pull the magazine release lever back with the other.
- Pull the magazine off upwards.
- Replace the cover on the camera opening.





6. Optics

Lenses

All ARRIFLEX lenses with a PL-mount can be used on the ARRIFLEX 435/435ES. Lenses with a \varnothing 41 mm standard or bayonet mount cannot be used. Heavy and long lenses, such as zoom-lenses, must be supported at all times.

Attaching Lenses

- Remove the protective cap from the lens mount receptacle by turning the bayonet ring ⇨ **photo** counter-clockwise as far as it will go and then pulling out the protective cap.



Never put your fingers into the lens mount receptacle.

- Push the lens into the lens mount receptacle without catching it at the edges. One of the four slots on the lens mount must fit over the index pin ⇨ **photo**.
- Press the lens flat onto the lens mount receptacle and pull the bayonet ring clockwise to tighten.

Note: For Super 35 shots the lens mount receptacle must be turned 180°. See *Chapter 10, Super 35*.

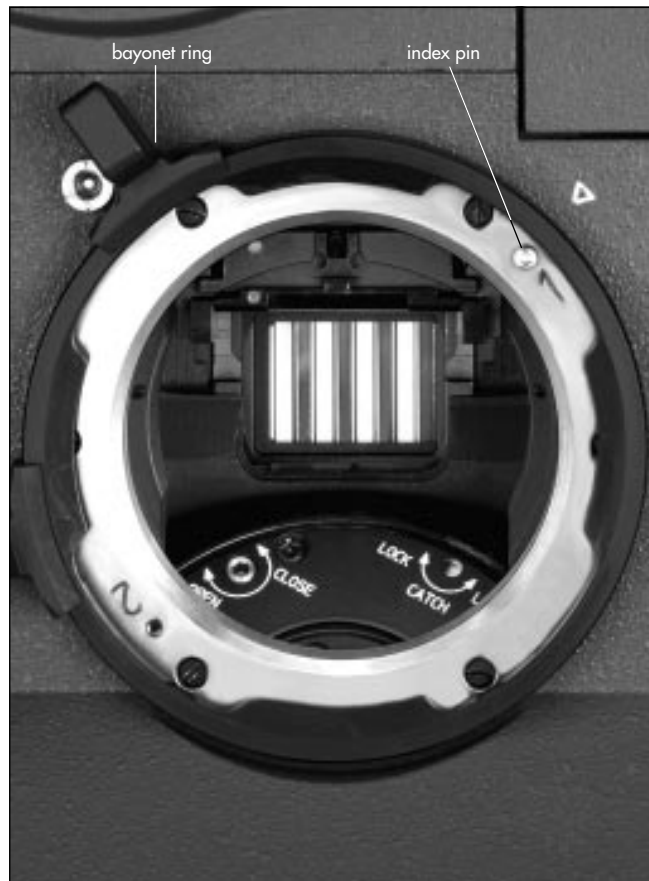



Viewfinder System

The viewfinder system on the ARRIFLEX 435/435ES can be swivelled in two axes. The viewfinder image is always upright and correct left-to-right when the viewfinder is swivelled within the main axes → **photo**.

A warning signal (red LED) for asynchronous running is reflected into the viewfinder.

An 80/20 beamsplitter for b/w video cameras is integrated into the viewfinder system. For colour video cameras, a beamsplitter with a ratio of 50/50 is also available, and can be fitted by a service center.

The entire viewfinder system can be replaced by a video finder (100%). An anamorphic viewfinder arm is also available.

An ARRIGLOW module is available as an option.

Using slide-in masks, the filming format currently in use can be displayed in the viewfinder as an illuminated frame with continuously adjustable brightness. The ARRIGLOW also displays the warnings ASY (asynchronous running), BAT (supply voltage too low) and END (end of film) in the viewfinder.

The Eyepiece

Removing the Eyepiece

- Hold the eyepiece with one hand and with the other turn the knurled ring ⇨ **photo** towards the "OPEN" position as far as it will go.
- Remove the eyepiece ⇨ **photo**.

Attaching the Eyepiece

- Ensure that the knurled ring is turned to the "OPEN" position.
- Position the eyepiece on the viewfinder.
- Turn the knurled ring ⇨ **photo** towards the "LOCK" position.
- Check that the eyepiece is correctly seated.

Adjusting the Diopter

The diopter compensation is fitted with a scale ⇨ **photo** of 1 to 12. Position "6" is normal focus.

- To adjust, turn the ring right/left until the ground glass markings are totally in focus.

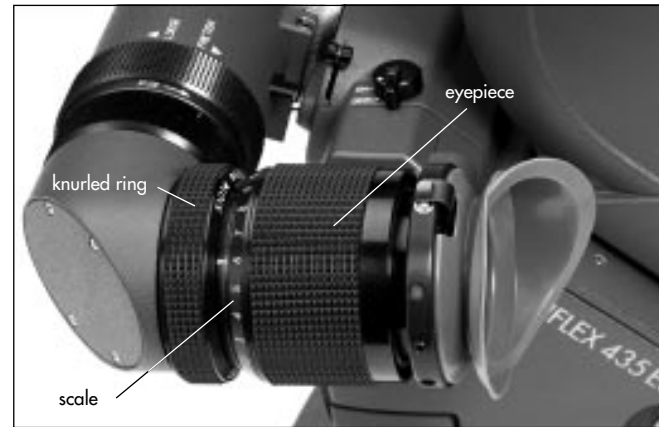

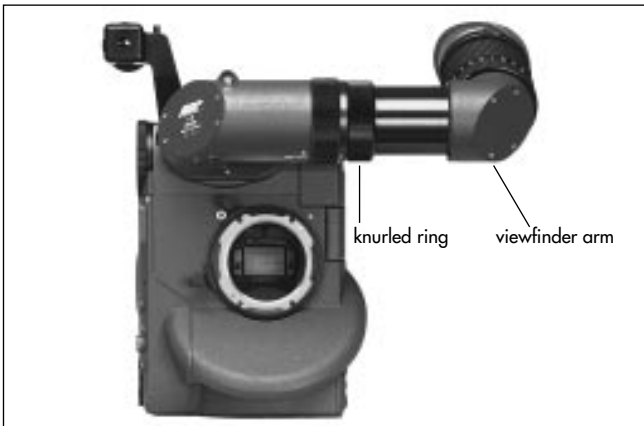
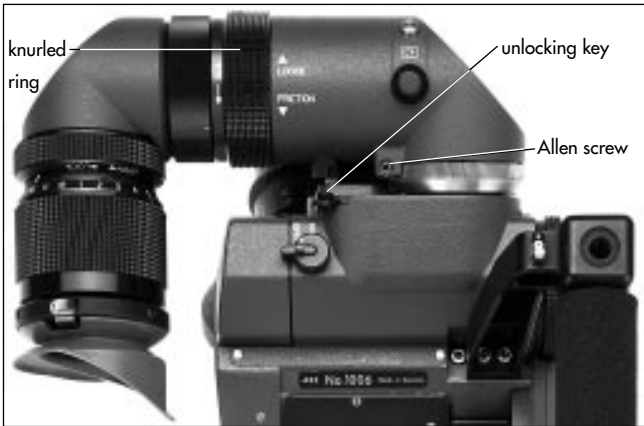

Adjusting the Viewfinder

Turning the Eyepiece

The eyepiece can be rotated 360° around the viewfinder arm. The eyepiece is held in adjusted position by friction.

- To set friction, turn the knurled ring ⇨ **photo** right/left until the desired friction has been reached.

Swivelling the Viewfinder Arm

The viewfinder arm can be swivelled approx. 270° left to right. On the left side of the camera the viewfinder arm locks into the horizontal position. The viewfinder arm friction can be altered if necessary by turning the Allen screw ⇨ **photo**.

- To adjust the viewfinder arm, release the locking mechanism by depressing the unlocking key ⇨ **photo**.
- Turn the viewfinder arm to the desired position.

Extending the Viewfinder Arm

The viewfinder arm can be telescoped continuously by approx. 50 mm.

- Turn the knurled ring ⇨ **photo** towards the "LOOSE" position.
- Pull the viewfinder arm ⇨ **photo** out to the desired length.
- Retighten the knurled ring.

Image Compensation

The viewfinder system is fitted with an automatic image compensation mechanism.

To enable setting a different image position in certain situations, the viewfinder system is additionally equipped with a manual image adjustment mechanism.

Manually Adjusting Image Compensation

- Depress the locking key ⇨ **photo** and hold depressed.
- Turn the adjustment knob ⇨ **photo** until the viewfinder image is in the desired position.

Reactivating Image Compensation

- Turn the adjustment knob ⇨ **photo** until this locks in position. Do not depress the locking key.

Note: The automatic image compensation locks in two positions, 180° apart. This allows the image compensation to be set to provide an upright image when using a finder extension.

If the viewfinder image is inverted without the finder extension, the image compensation must be adjusted to the opposite locking position.

Inverting the Image

- Depress the locking key ⇨ **photo** and keep depressed.
- Turn the adjustment knob ⇨ **photo** approx. 30°

- Release the locking key ⇨ **photo**.
- Keep turning the adjustment knob ⇨ **photo** until this locks in position.

Pivoting the Contrast Filter

To enable a subjective reduction of viewfinder contrast, a contrast filter (ND 6) can be pivoted into the optical beam path by means of a lever ⇨ **photo**.

- The lever ⇨ **photo** is brought into the "ON" position automatically by depressing the locking key ⇨ **photo**.
- For unrestricted viewing, turn the lever ⇨ **photo** back into the "OFF" position until it locks in.

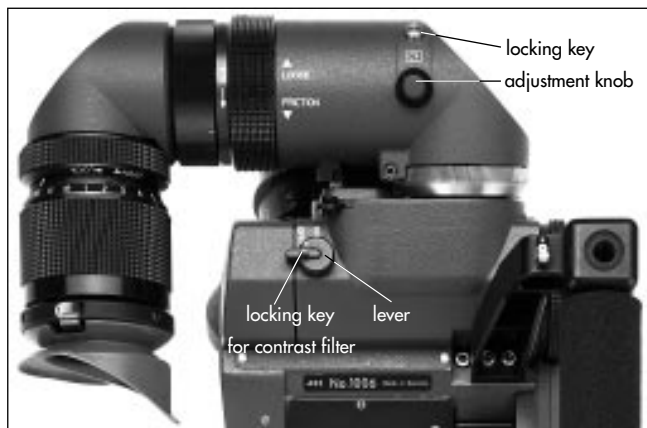

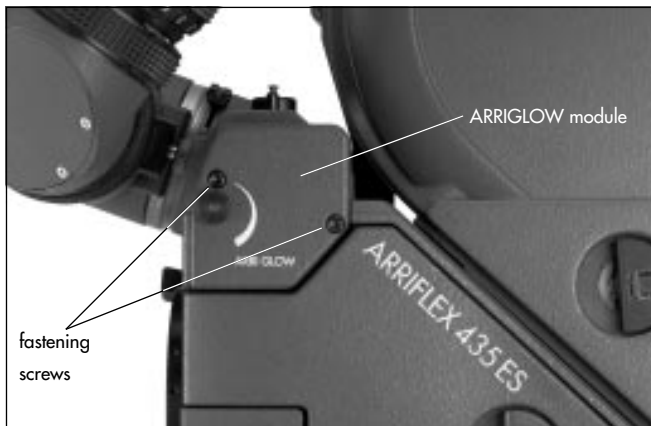

ARRIGLOW

Attaching ARRIGLOW

The ARRIGLOW module is available as an option. It allows illuminated format markings to be superimposed onto the viewfinder image with continuously adjustable brightness.

- Loosen both fastening screws ⇨ **photo** on the warning display module.
- Pull the warning display module off sideways.



*Attach the ARRIGLOW module straight.
Attaching at an angle could damage the plug.*

- Push on the ARRIGLOW module ⇨ **photo**.
- Screw both fastening screws tight.

Adjusting ARRIGLOW Brightness

The brightness of the illuminated format markings can be continuously adjusted by turning the adjustment knob ⇨ **photo**.

By turning the adjustment knob counter-clockwise as far as it will go, the ARRIGLOW can be turned off.

Exchanging the Format Mask

- Open the camera door as wide as possible.
- Grip the format mask ⇨ **photo** with the special forceps and pull downwards and out.
- Now grip the new format mask with the special forceps and push in with the notch ⇨ **photo** facing towards the rear until it locks in place securely.

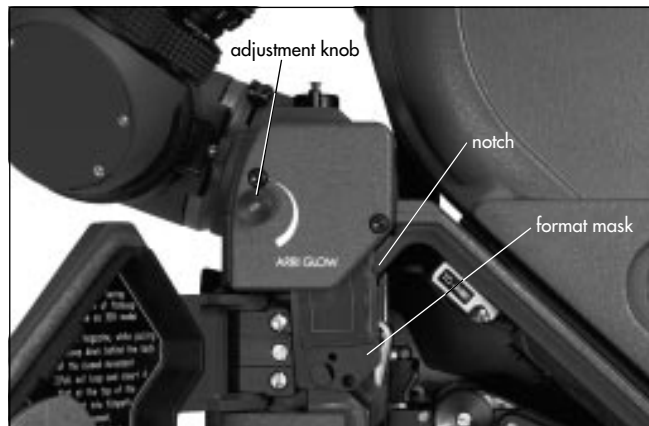

Exchanging the Viewfinder System

The entire viewfinder system can be replaced by a 100% video finder. See *Chapter 9, Accessories*.

Removing the Viewfinder System

Before removing the viewfinder system, the viewfinder arm should be brought back to its normal position.

- Loosen the three fastening screws ⇨ **photo**.
- Pull the viewfinder system up and off.

Attaching the Viewfinder System

- Position the viewfinder system on the camera body from above.
- Tighten the fastening screws.

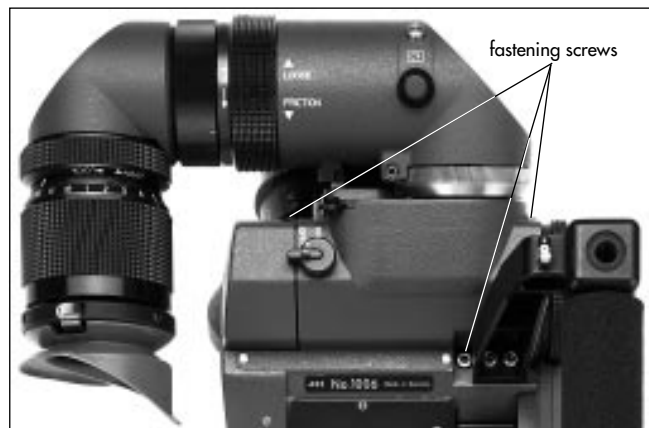



7. Camera Operation

Main Camera Switch

The main camera switch ⇄ **photo** is located on the back of the camera below the magazine opening.

- First switch on the mains unit (if used).
- Connect the camera to the mains unit or to the battery.
- Switch on the main camera switch.

In the "ON" position the camera is in standby. In the "OFF" position the camera is cut off from the power supply.





Running and Stopping the Camera

A "RUN"-button is located on the left side of the camera
 ⇨ **photo**.

Running the Camera



If the operation control indicator glows red while in standby, the camera is not ready and will not run (see "Overview of Display Symbols").

- Briefly depress the "RUN"-button. While the camera is running up, the operation control indicator ⇨ **photo** glows red. Once the set frame rate has been reached, the operation control indicator turns green.

Stopping the Camera

- Again depress the "RUN"-button ⇨ **photo** briefly. While the camera is running down the operation control indicator glows red. The mirror shutter automatically stops in a position that enables unrestricted viewing through the viewfinder. On reaching this position, the operation control indicator flashes green before going out.

Inching

Inching can be started by depressing the "PHASE"-button while the camera is in standby. If the "PHASE"-button is only briefly depressed, the movement rotates one revolution and the mirror shutter rotates half a revolution to enable an unrestricted view of the film gate (e.g. for checking the gate). If the "PHASE"-button is held depressed longer, the camera will inch forward at approx. 1 fps. The upper line of the display indicates the measured shutter angle, the lower line the measured voltage of the power supply.



While inching, shutter and movement are not exactly synchronized. As this can cause faulty exposures, do not film while inching.

Displaying and Setting Operational Parameters

The currently set operational parameters on the ARRIFLEX 435/435ES are displayed on the camera display ⇨ **photo** in various modes. The desired mode is selected via the "MODE"-button. In each mode the corresponding operational parameters can be set using the "SEL"- and "SET"-buttons ⇨ **photo**.

Note: Mode 1 is indicated ⇨ **photo** in the display by a black horizontal bar.

To prevent an unintentional alteration of the operational parameters the buttons "SEL", "SET", "PROG" and "PHASE" can be locked using the sliding switch "LOCK". If a button is depressed when the display is locked, the display will show the "OFF" sign.

Note: Locking the "PHASE"-button has no influence on the inching function.



Locking the "SEL"- and "SET"-buttons has no influence on accessories such as the RCU-1.

Overview of Display Modes

Mode 1 is displayed:

after switching on the camera,
after depressing the "RUN"-button or
30 seconds after the last operation.

Mode 4 and 5 can only be selected
if the functional expansion module is attached.

	1st Display Line	2nd Display Line	Adjustment Possibility
Mode 1	Total exposed film counter (m/ft) or take counter (m/ft) or mirror shutter angle of the ARRIFLEX 435ES	Frame rate (fps) or ESU, SU in standby and frame rate (fps) while running (external control connected) or Pr if a program is activated	Selection of a standard frame rate Configuration of the 1st display line on the ARRIFLEX 435ES
Mode 2	Programmed frame rate (PS) ESU, SU – external control connected Current shutter angle if a program is activated	Programmed frame rate (fps) Current frame rate if a program is activated	Programmed frame rate (forwards / reverse)
Mode 3	Total exposed film counter (m/ft) or take-counter (m/ft)	Power supply voltage (V)	Configuration of the film counter Unit of measurement (m/ft)
Mode 4	Time Code time (hours, minutes)	Time Code time (seconds, frames)	Time Code on / off Time Code time can only be set via the CCU or externally
Mode 5	Time Code user bits Time Code warnings	Time Code user bits	Time Code user bits can only be set via the CCU or externally
Mode 6	Volume of the acoustic warning signal	TCS-value or Voltage of the time code buffer battery (V)	Warning signal on / off Volume TCS-value
Mode 7	Stored program settings 435ES: set shutter angle	Frame rate (fps) Stored program settings	435ES: Setting of the shutter angle

Overview of Display Symbols

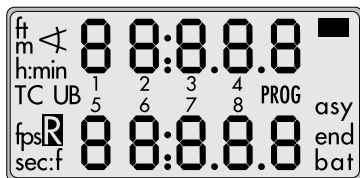

Symbol	Meaning
■	glows The display is in Mode 1.
bat	glows Battery voltage too low for the set frame rate ≤ 130 fps and voltage < 20.6 V 130 - 150 fps and voltage < 24V blinks Battery is too "soft", voltage will collapse on use
asy	glows Asynchronous operation (camera is not running at set frame rate) blinks Movement/shutter not synchronous
end	glows film end
fps	blinks The magazine is not suited to the set frame rate, or ESU is connected and no sync-frequency is available
PROG	glows The stored program is activated and can be started while the camera is running by depressing the "PROG"-button. blinks The activated program cannot be run with the set values: e. g.: incorrect magazine for the frame rate set in the program, or battery voltage too low for the frame rate set in the program.

Symbol	Meaning
↔	blinks Only on ARRIFLEX 435ES: The shutter is mechanically locked in electronic operation or the electronic shutter function is switched off. The symbol blinks and the operation control indicator glows red although the shutter is not locked: The electronic shutter adjustment is defective – the electronic shutter adjustment can be switched off see chapter 5.
R	glows Reverse operation is switched on.
TC	glows TC-generator is switched on and set. blinks TC-generator is switched on during running: no recording during standby: the last synchronization was over 8 hours ago additional acoustic warning, see also TC warning display.

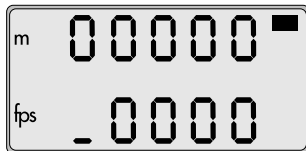

Display: Movement Open

The display shows if the movement has not been locked correctly into operating position.

The operation control indicator glows red the movement block is not correctly locked, the camera is not operational.

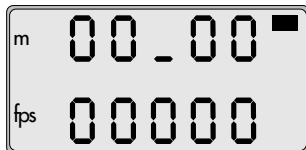

Display: Warning of Reverse Operation with an ARRIFLEX 35 III 300 m Magazine

Reverse operation is not possible with an ARRIFLEX 35 III 300 m magazine. If the camera is set to reverse operation and an ARRIFLEX 35 III 300 m magazine is attached, this warning will show in the camera display.

Note: If other digits of the display show a bar instead of a zero, see *Appendix*

Film Counter

Displaying the Film Counting Values (Modes 1 and 3)

Film counting values are shown in Modes 1 and 3.

Two different counting values are shown respectively:

- the total amount of exposed film or
 - the take length (amount of film used in an individual take)
- A "t" in the first digit of the upper display line indicates the display of take length.

Setting the Film Counter Configuration (Mode 3)

The display configuration can be set individually.

The two shown combinations are possible:

The desired display configuration can be set in Mode 3:

- Change from Mode 1 to Mode 3 by depressing the "MODE"-button twice.
- Depress the "SEL"-button twice; the first digit in the upper display line blinks.
- Within three seconds, depress the "SET"-button.
- The currently set counting value of Mode 3 is displayed. The corresponding counting value in Mode 1 is automatically altered.

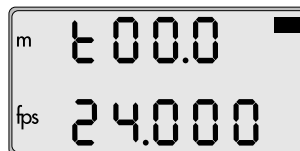

Mode 1
Take length or
Total exposed film

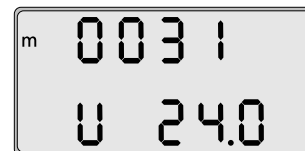

Mode 3
Total exposed film or
Take length

Resetting the Film Counter (Modes 1 and 3)

- Change to the mode which shows the total amount of exposed film ("MODE"-button).
- The total exposed film counter can be set to zero by depressing the "SET"-button (for at least 3 seconds) while in standby.
- The take length counter is automatically reset each time the camera is started.

Changing the Unit of Measurement (Meters/Feet) (Mode 3)

Standby Operation

- Change from Mode 1 to Mode 3 by depressing the "MODE"-button twice.
- Depress the "SEL"-button once; the symbol m/ft blinks.
- Depress the "SET"-button within three seconds to change the unit of measurement.

Displaying the Angle of the Mirror Shutter (Mode 1)

- As long as the "PHASE"-button is depressed while in standby, the set angle of the mirror shutter appears in the upper display line.
The camera runs at inching speed.

Setting the shutter angle on the 435/435ES:
see *Chapter 5*.

Configuring Mode 1

On the ARRIFLEX 435ES a constant display of the shutter angle can be configured in Mode 1:

- Depress the "SEL"-button repeatedly until the upper display line blinks.
- The "SET"-button switches between film counter and shutter angle.

Frame Rates

The ARRIFLEX 435/435ES offers the possibility to set and store two frame rates. It is possible to select and store:

- a standard frame rate (23.976, 24, 25, 29.97 and 30 fps),
- and a freely programmed frame rate in increments of 0.001 fps for frame rates up to 100 fps and above 100 fps in increments of 0.01 fps.

The frame rate is activated via the "NORM/PS"-switch ⇨ **photo** on the left of the camera. The "NORM"-position corresponds to the standard frame rate, the "PS/CCU"-position to the freely programmed frame rate.

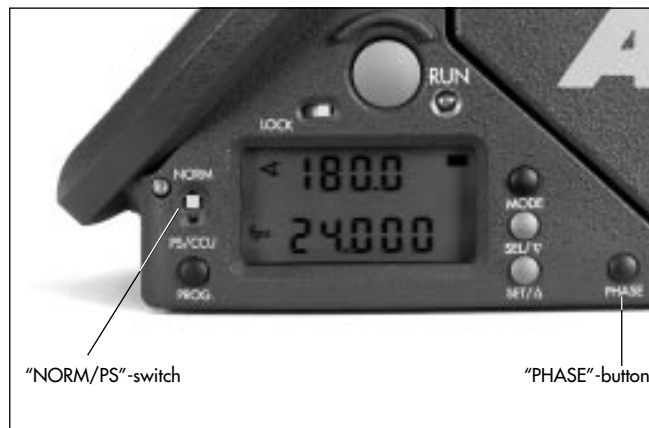

Selecting a Standard Frame Rate (Mode 1)

Standby Operation

- The camera must be in Mode 1 and the "NORM/PS" switch must be in the position "NORM".
- Depress the "SEL"-button repeatedly until the desired frame rate is selected. Within 3 seconds, confirm this choice by depressing the "SET"-button, otherwise the initial setting is retained.

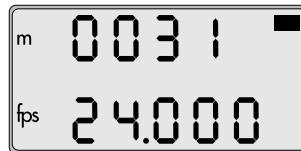

Setting a Programmed Frame Rate (Mode 2)

Standby Operation

- Change from Mode 1 to Mode 2 by depressing the "MODE"-button once.
- Depress the "SEL"-button repeatedly until the digit to be set blinks.
- Depress the "SET"-button repeatedly until the desired value is reached.
- Repeat this procedure until all digits are set to the desired values. For frame rates below 100 fps, a "0" should be entered as the first digit, for frame rates above 100 fps, a "1". A final confirmation of the set frame rate is not necessary.

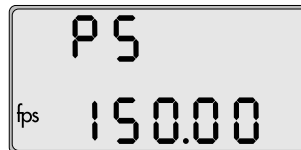

Note: The frame rate can be set between 1 and 150 fps. For frame rates over 130 fps, a power supply voltage greater than 24 V is necessary.

Note: An internal buffer battery ensures that the programmed frame rate is stored even if the camera is not switched on at the main switch. This battery has a lifetime of approx. 10 years. If the programmed frame rate is not available when the camera is switched on again, the buffer battery must be exchanged by an ARRI service center.

Switching Between Forward and Reverse Operation (Mode 2)

Standby Operation

- Change from Mode 1 to Mode 2 by depressing the "MODE"-button once.
- Depress the "SEL"-button; "Cd" blinks.
- Hold the "SET"-button depressed for more than three seconds. The display shows an "R" for reverse operation at the bottom left.

The frame rate can be altered as described above.

Changing the Frame Rate while the Camera is Running

By means of the "NORM/PS"-switch it is possible to switch between the standard frame rate ("NORM") and the programmed frame rate ("PS/CCU") while the camera is running.

Note: The attached magazine must be suited for the programmed frame rate. For HS-operation above 130 fps, an appropriate power supply must be connected.

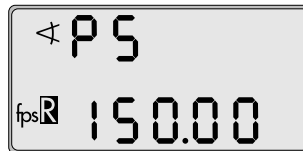

Fine-Tuning the Programmed Frame Rate (PS-Mode)

Fine-tuning of the programmed frame rate can be carried out while the camera is running by means of the buttons "SEL" (slower) and "SET" (faster). The setting can be adjusted in increments of 0.001 fps (1.000 to 99.999).

- Set the "NORM/PS" switch to "PS/CCU".
- Run the camera.
- Depress the "MODE"-button once to change to Mode 2.
- With the buttons "SEL" (slower) and "SET" (faster) change the frame rate.

Shifting Phase

To film quartz-synchronized monitors, hold the "PHASE"-button depressed after the camera has run up until the horizontal bar is no longer visible in the viewfinder. The frame rate will increase by 0.2 fps while the button is depressed.



Displaying the Power Supply Voltage (Mode 3)

- Change from Mode 1 to Mode 3 by depressing the "MODE"-button twice. The power supply voltage is shown in the lower line of the display.

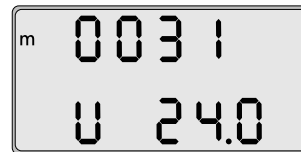

Display	Warning tone on start	Warning tone on stop
LS _ _	off	off
LS =	on	off
LS _ -	off	on
LS - -	on	on

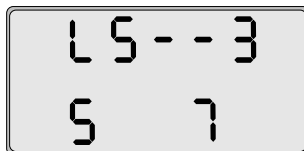
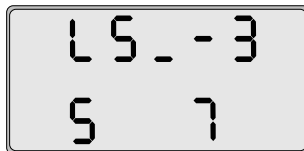

Switching On and Off the Warning Signal for Asynchronous Running (Mode 6)

Standby Operation

- Change from Mode 1 to Mode 6 by depressing the "MODE"-button five times (or three times if no functional expansion module is attached).
- By depressing the "SEL"-button twice, activate the display for setting the warning signal.
- Within three seconds, depress the "SET"-button to select one of the four settings.
- Depressing the "MODE"-button confirms the selection and changes the display back to Mode 1.

Setting the Volume of the Warning Signal

- Change from Mode 1 to Mode 6 by depressing the "MODE"-button five times (or three times if no functional expansion module is attached).
- Depress the "SEL"-button three times to activate the display for setting the warning signal volume.
- Select the desired volume with the "SET"-button.



At volume level 0 the acoustic TC-warning is also switched off.

0...off

3...maximum volume

8. Video-Assist-System

The video-assist-system provides a high quality, practically flicker-free monitor image for PAL or NTSC. The video-assist-system consists of the video optic VO-2, the 1/2" colour video camera CCD 2-FR and the anti-flicker processor AFP-2.

The brightness of the video image is automatically adapted to the given lighting conditions. This adjustment can also be carried out manually. The white balance is set to standard values for interior and exterior lighting situations. The integrated image-storage technology enables viewing of a stored image or the alternation between the real and the stored image - e.g. to align the camera to an earlier scene or for stop-motion filming.

The video camera CCD 2-FR is equipped with a GEN-LOCK input. This allows the video-assist-system to be synchronized to an external video signal.

In the standard configuration, the ARRIFLEX 435/435ES is equipped with a beamsplitter which reflects 20% of the viewfinder beam into the video camera (b/w video). A 50/50 beamsplitter (colour video) can be fitted in a service center.

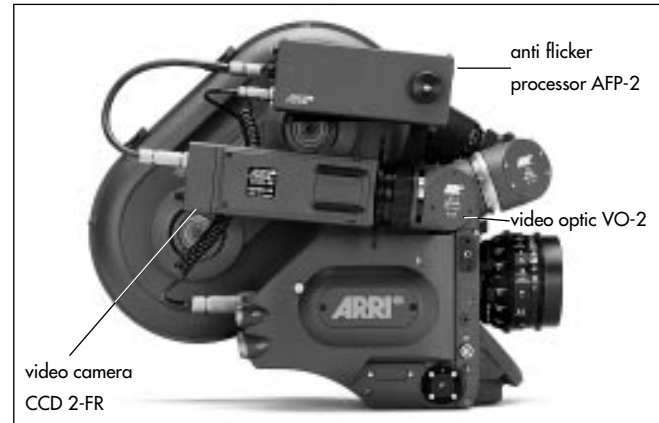



Mounting the Video-Assist-System

Mounting the Video Optic

- First unscrew the cover ⇨ **photo** on the viewfinder system. If the cover cannot be removed by hand, use the special wrench ⇨ **photo** .
- Unscrew the cover on the video optic by turning the retaining ring.
- Remove the cover.
- Attach the video optic. The index pin ⇨ **photo** on the viewfinder system defines the correct position.
- Tighten the retaining ring by hand.

Note: The video optic is tilted upwards by 5°.

Removing the Video Optic

- Hold the video optic firmly in one hand.
- Loosen the retaining ring with the other hand.

Note: If the retaining ring cannot be loosened by hand, use the special wrench ⇨ **photo** .

- Pull the video optic off sideways.
- Replace the cover on the viewfinder system and tighten by hand.

Mounting the Video Camera

- Unscrew the protective cover from the C-mount on the video optic.
- Unscrew the protective cap of the video camera.
- Screw the video camera ⇄ **photo** onto the C-mount thread on the video optic.

Mounting the Anti-Flicker Processor AFP-2

- Screw the dovetail-adapter ⇄ **photo** onto the grip system of the ARRIFLEX 435/435ES.

Note: The dovetail-guide must be also be tilted approx. 5° upwards to correspond to the video optic.

- Then slide the anti-flicker processor into the dovetail-guide and screw tight.

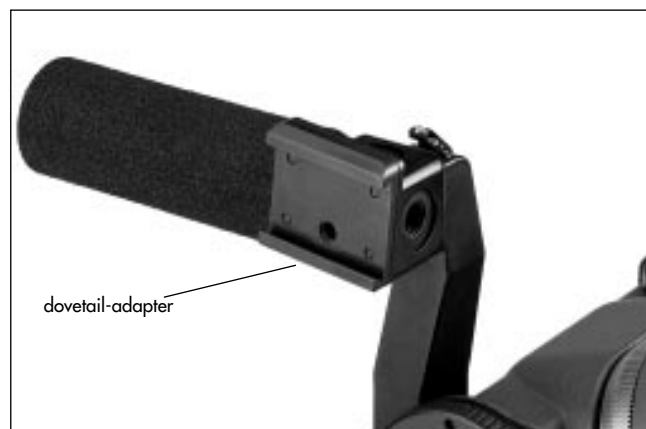
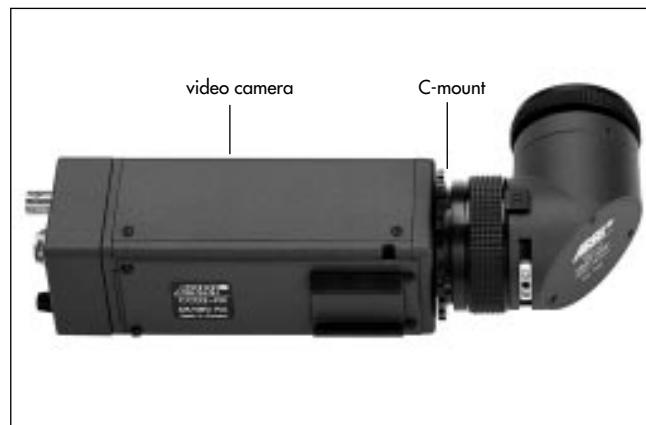

Wiring the Video-Assist-System

- It is imperative to turn off the main switch on the ARRIFLEX 435/435ES.
- The anti-flicker processor AFP-2 is connected from the socket MOVIE CAMERA to the RS-socket of the camera with the cable KC 37, or to the 12 V socket with the cable KC 36.
- Plug the cable KC 34 into the socket VIDEO CAMERA on the AFP-2 and into the video camera.
- The video signal for the monitor is available from two sockets on the AFP-2:
Mini monitor: socket MINI MONITOR
Standard video monitor: BNC-socket VIDEO OUT



The BNC-socket "VD in" on the video camera CCD 2-FR is used for synchronizing to an external video signal. Do not connect as a video output!

- Set the rotary code switch on the underside of the anti-flicker processor to "9".
- Switch on the main switch of the ARRIFLEX 435/435ES.
- Switch on the video-assist-system using the switch on the AFP-2.

Note: The anti-flicker function can be optimized by adjusting the slit screw "PHASE ADJ".

Adjusting the Video Optic

Adjusting the Image Position

- Loosen the clamping ring ⇨ **photo** approx. 15° (as seen in the direction of filming, counter-clockwise).
- Adjust the angle position by turning the video camera, at the same time checking the image on the monitor.
- Set the horizontal position with the adjustment screw ⇨ **photo** marked X, using a 1.3 mm Allen key.
- Set the vertical position with the adjustment screw ⇨ **photo** marked Y, using a 1.3 mm Allen key. If the adjustment screw ⇨ **photo** is loosened, check that the image follows. Otherwise press the video camera gently upwards at the flange.
- Retighten the clamping ring.

Adjusting the Aperture

- Loosen the aperture clamp on the aperture adjustment knob ⇨ **photo** .
- Set the aperture via the monitor.
- Retighten the aperture clamp.

Adjusting Focus

- Loosen the clamp on the focus adjustment ring ⇨ **photo**.
- Check focus on the monitor and adjust with the focus adjustment ring. For more accurate judgement, the aperture can be completely opened.
- Tighten the clamp on the focus adjustment ring.

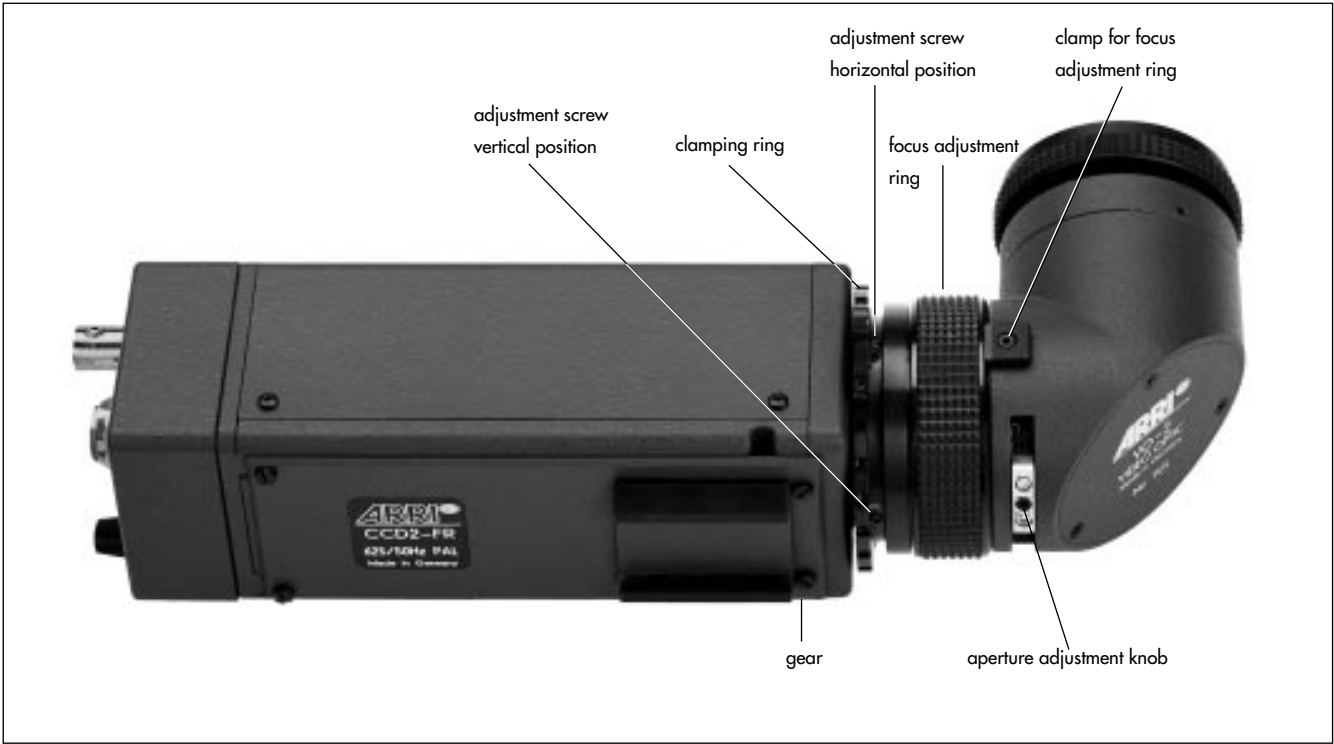

Note: The focus range of the video optic can be shifted with the gear ⇨ **photo** on the video camera.



9. Accessories

Anamorphic Viewfinder AVF-2

When using anamorphic lenses, the AVF-2 allows de-squeezed viewing of the ground glass image. This viewfinder arm can also be switched over to check the anamorphically squeezed image. The anamorphic viewfinder AVF-2 can be fitted in place of the standard viewfinder arm by a service center or in a rental house.

- To switch over the viewfinder image, turn the switching knob ⇄ **photo** . The knob does not need to be unlocked.

All other operating elements are identical in function to those on the standard viewfinder.

The anamorphic viewfinder can also be used together with the finder extender FE-3. A mechanical remote control facilitates switching over the viewfinder image in this operating position. The remote control is attached under the viewfinder arm to the shaft of the switching knob. The operating knob can be attached to the finder extender.



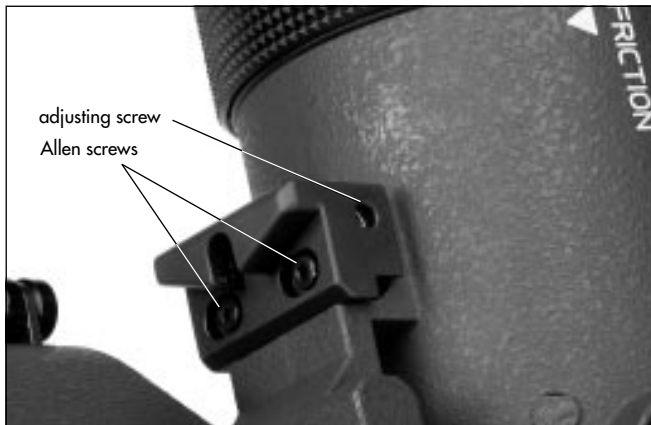

Adjusting the AVF-2

Unlike the standard viewfinder, the anamorphic viewfinder will only provide an undistorted image in horizontal, locked position. The locking stops of the AVF-2 can be adjusted to an exactly horizontal position.

Using the AVF-2 on the Left Side of the Camera

- Loosen (do not remove) the two Allen screws ⇨ **photo** in the locking stop.
- Turn the adjusting screw ⇨ **photo** with an Allen key until the viewfinder image is free of distortion.
- Retighten the Allen screws.

Using the AVF-2 on the Right Side of the Camera

The AVF-2 can also be locked into horizontal position on the right side of the camera. An adjustable brace ⇨ **photo** can be fitted to the camera for this purpose.

The brace is attached to the accessory flange on the camera body with a screw ⇨ **photo** . The horizontal position of the AVF-2 on the right side of the camera is adjusted solely on the brace.

- Loosen the clamping screw ⇨ **photo** .
- Using the adjusting screw ⇨ **photo** , pivot the brace until the viewfinder image is free of distortion.
- Retighten the clamping screw.

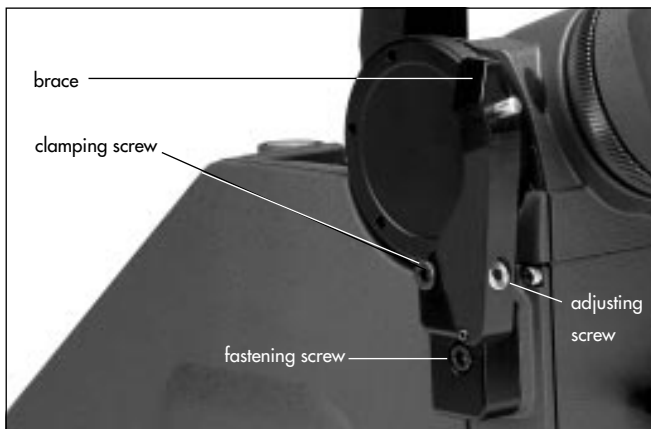

Video Viewfinder VT-2

The video viewfinder VT-2 is a 100%-video-tap module. It can easily be fitted in place of the standard viewfinder system for Steadicam or crane operation. The same video optic that is used on the standard viewfinder system can be also fitted to the video viewfinder.

Mounting the Video Viewfinder

Removing the Standard Viewfinder System

- Lock the viewfinder arm into horizontal position.
- Unscrew the three fastening screws of the standard viewfinder system ⇨ **photo** .
- Pull the viewfinder system up and off.

Mounting the VT-2

- Position the VT-2 on the camera body from above.
- Tighten the fastening screws.

Mounting the video optic is carried out in the same way as on the standard viewfinder system (see *Chapter 8*)

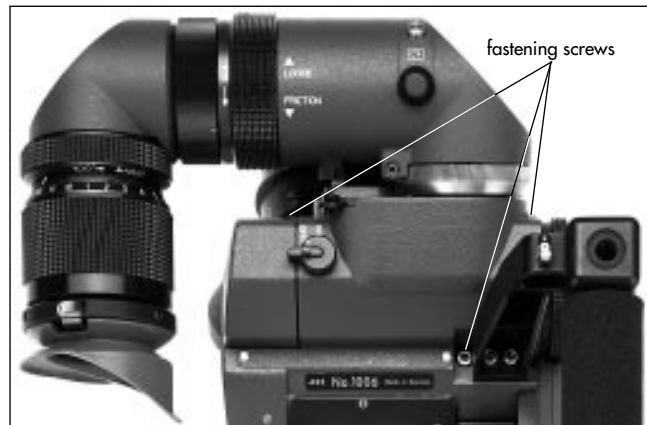

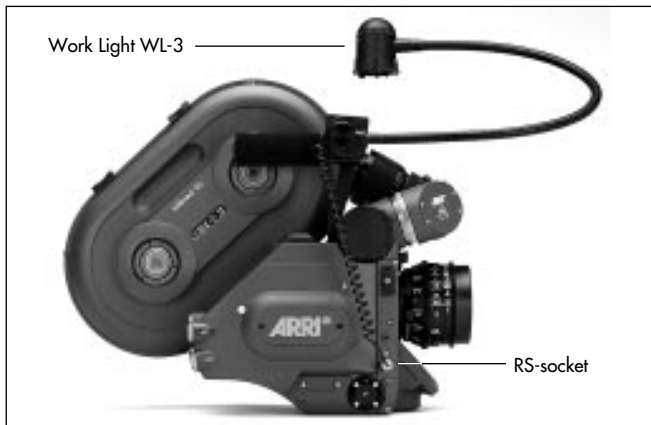

Work Light WL-3

- Screw the dovetail-adapter to the handgrip.
- Slide the work light into the dovetail-guide and clamp.
- Connect the plug to the "RS"-socket ⇨ **photo** .
- By adjusting the flexible arm, bring the work light into the desired position. The work light can be turned on and off with the ring on the lamp head ⇨ **photo** . The brightness of the work light can be adjusted with the mechanical aperture.

Heated Eyecup HE-3

The heated eyecup prevents the eyepiece ⇨ **photo** from fogging in low temperatures e.g. when filming outdoors in winter.

- Pull the normal eyecup off the eyepiece, then place the heated eyecup on the eyepiece.
- Plug the heated eyecup either with cable KC-26S to the 11-pin accessory socket, or with cable KC-42S to the RS-socket.
- Set the heating level with the toggle switch ⇨ **photo** :
 "LO": low heat output
 "HI": higher heat output.



If the camera and accessories are powered by battery, it is recommended to switch off the eyecup-heating during extended breaks in filming.

Remote Run Switch RS-4

- Attach the remote run switch with the spring clamp ⇨ **photo** (e.g. to the pan handle).
- Plug the RS-4 plug into the "RS"-socket.



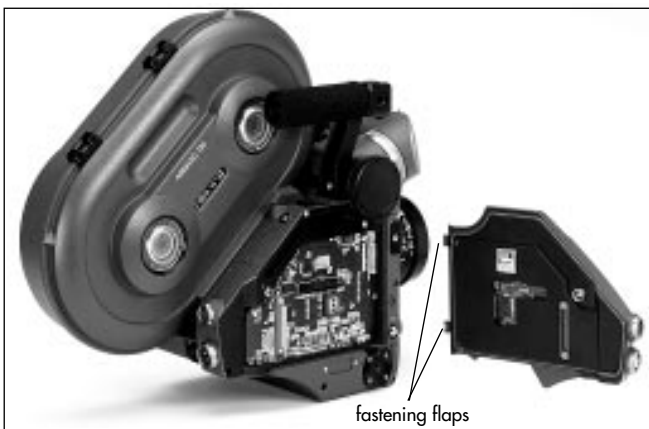

Functional Expansion Module FEM

The functional expansion module expands the application possibilities of the ARRIFLEX 435. It is included in the standard package of the ARRIFLEX 435ES.

The TC-generator, the TC-buffer and the TC in- and outputs are integrated into the FEM. In addition, the FEM offers interfaces for camera accessories:

"ACC" socket: ESU-1, RU-1

"CCU" socket: CCU-1, RCU-1, LCC and RS 232 interface.

Note: Use of the RU-1 is possible, but not recommended. The range of frame rates that can be adjusted with the RU-1 is limited to 8.1 - 130 fps. Furthermore, the set frame rate does not correspond to the scale on the adjusting wheel. The exposure time in "Auto"-mode is also not 1/100 s, but 1/260 s.

The FEM is mounted directly onto the camera in place of the electronic cover.

- Switch off the camera's main switch and disconnect the camera from the power supply.
- Unscrew the fastening screw on the electronic cover.
- Swing the electronic cover away to the side and pull off backwards.
- Place the fastening flaps of the FEM  into the recesses in the camera housing.



Ensure that the fastening flaps are properly positioned in the camera housing before swinging the FEM into place, otherwise they may catch and be damaged!

- Swing the functional expansion module onto the camera housing.
- Screw tight the fastening screw ⇨ **photo** on the functional expansion module.

External Synchronization Unit ESU-1

The use of the ESU-1 ⇨ **photo** is only possible with the function expansion module attached to the camera. The external synchronization unit ESU-1 can be used with the ARRIFLEX 435/435ES as well as with the ARRIFLEX 535, 535B and 16SR 3. It allows synchronization of the camera to other equipment such as TV monitors. By means of a BNC-socket, it is possible to synchronize to an external standard video signal (50/60 Hz) or, through an inductive pickup, to a computer or video monitor. The camera display shows "ESU" in the upper line. The ESU-1 can be used for frame rates from 3 to 60 fps.



Note: The ARRIFLEX 435/435ES can additionally be synchronized within a frame rate range of 3 to 150 fps. An appropriate cable is available on request.

The frame rate is indicated on the camera display in Mode 2. A phase shifter and a pilotone generator have also been integrated into the external synchronization unit. The synchronization is retained even when the camera is switched off. See TECHN. INFORMATION "External Synchronization Unit ESU-1".

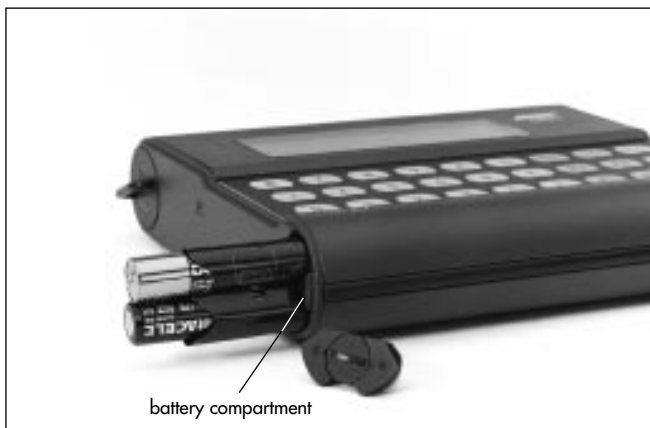

Camera Control Unit CCU-1

The CCU-1 ⇨ **photo** can only be used in conjunction with the functional expansion module. The electronic adjustment of the shutter angle is only possible on the ARRIFLEX 435ES. The camera control unit CCU-1 enables control of the following functions:

- Starting and stopping the camera.
- Selection of the frame rate.
- Selection of the shutter angle (only 435ES).
- Checking all set operational parameters.
- Entry of programmed frame rate changes (programs).
- Entry of programmed shutter angle changes (programs) (only 435ES).
- Display and operation of the film counter.
- Setting of warning signals.
- Display and setting of TC-time (time code) and TC-user bits.
- Display of the set TC-sensitivity in the REMOTE menu.

The camera control unit is supplied with power by the camera. If the camera is not connected, the camera control unit will be powered by the internal batteries. As the life of the camera control unit's batteries is limited to approx. 5 hours, the display illumination switches off

approx. 10 seconds after the last operation when it is being run on batteries, and the camera control unit itself switches off after approx. 5 minutes.

Replacing the Batteries

- Open the battery compartment ⇨ **photo** with a coin.
- Pull out the battery pack.



Pay attention to the correct polarity of the battery pack!

- Insert batteries as indicated on the battery pack.
- Insert the battery pack into the camera control unit and close the battery compartment.

Connecting the Camera Control Unit

- Switch off the main camera switch (position "OFF").
- Plug the cable KC 24S (2.4m) or KC 30S (20m) into the socket on the side ⇨ **photo** of the camera control unit, pressing the slide on the plug in the direction of the plug.
- Plug the cable into the CCU-socket ⇨ **photo** on the camera.
- Switch on the camera.
- Switch on the camera control unit with the red button ⇨ **photo** on the side.



Key Functions in all Menus

Key	Function
RUN	Starts and stops the camera.
SEND	Sends the selected values to the camera.
HELP	Shows the help text for the activated menu. Cannot be used in the input mode. The help text can be exited by depressing the ENTER-key.
EXIT	Ends input mode or exits the activated menu.
	Switches display illumination on / off.

Error Displays

In the case of operational errors on the CCU-1, the display on the camera control unit will show an error display that disappears again after the next key operation. Additionally, an acoustic signal will sound. This can be turned off.

The Main Menu

When the camera control unit is switched on, the main menu appears on the display. It enables access to the sub-menus. It also shows whether the camera is switched off (OFFLINE), is in standby (STANDBY) or is running (RUN). In addition, the frame rate set on the camera is displayed.

- With the keys "1" to "8", choose the desired menu. The menu **FORMAT (4)** is intended for the **ARRIFLEX 535** and has no function on the **ARRIFLEX 435/435ES**. On the **ARRIFLEX 435** the menu **SHUTTER (2)** has no function.

The SPEED Menu

With the **SPEED** menu any frame rate within the acceptable range can be set, from 1 to 99.999 fps in increments of 0.001 fps, above 100 fps in increments of 0.01 fps. The frame rate can be altered in standby as well as while the camera is running. In the upper line, the frame rate currently set on the camera control unit is displayed, and below that, the frame rate of the camera.

- Switch the sliding switch ⇄ **photo** on the camera to "PS/CCU".
- Using keys "1" to "7", select one of the standard frame rates listed in the **SPEED**-menu. The selected frame rate is displayed in the uppermost line.
- Transfer the selected value to the camera with the "SEND"-key.

Alternatively, other frame rates within the acceptable range can be entered directly:

- Switch the sliding switch ⇄ **photo** on the camera to **PS/CCU**.
- Depress key "8" (**VAR**) in the **SPEED** menu.
- Enter the desired frame rate.

- If digits after the decimal point are to have the value 0, these need not be entered. Complete the input with the “ENTER”-key. The selected frame rate is displayed in the uppermost line on the CCU.
- Transfer the chosen value to the camera with the “SEND”-key.

All selected frame rates within the acceptable range can be fine-tuned, from 1 to 99.999 fps in increments of 0.001 fps, above 100 fps in increments of 0.01 fps. This can be done in standby or while the camera is running.

To carry out a fine-tuning of the frame rate:

- Switch the sliding switch on the camera to PS/CCU.
- Pre-select the frame rate.
- Depress key “9” in the SPEED menu.
- Switch the camera to Mode 2.
- Carry out fine-tuning:
 - Increase frame rate with key F1
 - Decrease frame rate with key F2
- Exit fine-tuning with the “EXIT”-key.



sliding switch "NORM - PS/CCU"

The SHUTTER Menu

This menu has no function on the ARRIFLEX 435.

With the SHUTTER menu, shutter angles within acceptable range of 11.2° to 180° can be set as desired with an accuracy of 0.1°. The shutter angle can be changed in standby or while the camera is running. In the upper line the shutter angle currently set on the camera control unit is displayed, below that the shutter angle of the camera.

- Using keys "1" to "7", select one of the standard shutter angles listed in the SHUTTER menu. The selected shutter angle is displayed in the uppermost line.
- Transfer the selected value to the camera with the "SEND" key.

Alternatively, other shutter angles within the acceptable range can be entered directly:

- Depress key "9" (VAR) in the SHUTTER menu.
- Enter the desired shutter angle.
- If the digit after the decimal point is to have the value 0, this needs not be entered. Complete the input with the "ENTER"-key. The selected shutter angle is displayed in the uppermost line on the CCU.
- Transfer the chosen value to the camera with the "SEND"-key.

The REMOTE Menu

In the REMOTE menu the camera control unit displays the same information as the camera display. The last digit after the decimal point will be suppressed (4 digits instead of 5 as in the camera display).

The keys "F1" to "F4" assume the functions of the operating elements on the camera. The lower line of the CCU display shows the key functions:

- F1 "PHASE" -button
- F2 "MODE" -button
- F3 "SET" -button (RESET on the CCU)
- F4 "PROG" -button (program)

Operating the camera in the REMOTE menu is analogous to operation with the respective buttons on the camera.

The TIMECODE Menu

In the TIMECODE menu the current values are displayed: the time code time and user bits last entered on the CCU as well as the time code time and user bits of the camera.

Changing Time Code Time

- Depress key "5" to change to the time code menu.
- Depress key "1" - "TIMECODE" is displayed against a dark background.
- Depress the "ENTER"-key - the camera control unit is ready for input of the new TC-time.
- Enter a TC-time value within the acceptable range of 00:00:00 to 23:59:59 - the new TC-time is displayed. Confirm the input by depressing the "ENTER"-key; all unfilled digits will default to zero.
- Transfer the new TC-time to the camera with the "SEND"-key.

Changing Time Code User Bits

- Depress key "2" - "USERBITS" is displayed against a dark background.
- Depress the "ENTER"-key - the camera control unit is ready for input of the new user bits.
- Enter up to 8 user bits with figures 0-9 or letters A-F - the new user bits are displayed. Confirm the input by depressing the "ENTER"-key; all unfilled digits will default to zero.
- Transfer the new user bits to the camera with the "SEND"-key.

Note: On productions lasting several days we recommend that the date and the camera number be entered as user bits (e.g. 280895C1) in order to ensure clear identification of the film stock.

The **OPTIONS** Menu

The **OPTIONS** menu allows access to the sub-menus **ASYNC-MODE**, **LENGTH UNIT**, **END WARNING** and **COUNTER DISPLAY MODE**.

Note: The menu point **END WARNING** is not available on the **ARRIFLEX 435/435ES**.

- With the keys "1" to "4", select the desired function.

ASYNC-MODE

The **ASYNC** mode enables switching the warning signal for asynchronous running on and off. There are four possibilities available:

	Warning tone on camera start	Warning tone on camera stop
1	off	on
2	on	off
3	on	on
4	off	off

- Select the desired setting with the corresponding key.
- Transfer the chosen setting to the camera with the "SEND"-key.

LENGTH-UNIT

The **LENGTH-UNIT** mode enables switching the film counter between meters and feet.

- Select meters with key "1" or feet with key "2" - the selected unit of measurement is displayed against a dark background.
- Transfer the chosen setting to the camera with the "SEND"-key.

COUNTER DISPLAY MODE

The **COUNTER DISPLAY** mode enables changing the configuration of the film counter.

There are three possible combinations:

Note: The third menu point is not available on the **ARRIFLEX 435/435ES**.

	camera-diplay Mode 1	camera-display Mode3
1	total exposed film counter	take counter
2	take counter	total exposed film counter
3	total exposed film counter	remaining film counter

- Select the desired combination with the corresponding key.
- Transfer the chosen setting to the camera with the "SEND"-key.

The PROGRAM Menu

The PROGRAM menu enables writing and storing of programs (ramps) to change the frame rate and shutter angle (only on the ARRIFLEX 435ES).

Up to 6 programs can be stored by the CCU-1. One at a time can be transferred to the camera by depressing the "SEND"-key. If the functional limits of the camera are exceeded, the CCU-1 will show an error reading when the selected values are sent to the camera.

General information:

- The "FETCH"-key transfers a program that is already stored in the camera to the selected memory area of the CCU-1.
- The "DELETE"-key deletes the selected memory area.
- The "E" (edit)-key initiates the input of new values with the keys.

Note: Frame rate programs (ramps) are defined by a starting frame rate, an end frame rate and an adjustment time.

In the same manner, the shutter angle can be changed simultaneously within given limits.



sliding switch "NORM - PS/CCU" "PROG"-button

Ramping with the ARRIFLEX 435

The ARRIFLEX 435 is, unlike the ARRIFLEX 435ES, not equipped with an electronically adjustable shutter. Therefore exposure compensation through parallel adjustment of the shutter angle during frame rate changes is not possible.

Speed Ramping with the ARRIFLEX 435

Note: This description does not apply to the ARRIFLEX 435ES

- Depress key "7" to change to the PROGRAM menu.
- With keys "1" to "6", activate one of the available memory areas.
- Depress the "E"-key. The values can now be edited.
- Enter the desired starting frame rate.
If the digits after the decimal point need not be entered, complete the entry with the "ENTER"-key.
- Confirm the displayed shutter angle (value should be between 11.2° and 180°) with the "ENTER"-key.
This value will not be transferred to the camera as the mirror shutter of the ARRIFLEX 435 is not electronically adjustable.

- Enter the desired end frame rate.
If the digits after the decimal point need not be entered, complete the entry with the "ENTER"-key.
- Confirm the displayed shutter angle (value should be between 11.2° and 180°) with the "ENTER"-key.
This value will not be transferred to the camera as the mirror shutter of the ARRIFLEX 435 is not electronically adjustable.
- Enter the desired ramp time.
If the digit after the decimal point needs not be entered, complete the entry with the "ENTER"-key.
- Transfer the program to the camera by depressing the "SEND"-key.

Note: A program previously stored in the camera will be erased by this process.

Ramping with the ARRIFLEX 435ES

User Defined Ramping:

Note: This function is not available on the ARRIFLEX 435 as it is not equipped with an electronically adjustable mirror shutter.

In user defined ramping the user can set

- the starting frame rate and the starting shutter angle,
- the end frame rate and the end shutter angle,
- and the ramp time

independently of each other.

- Depress key "7" to change to the PROGRAM menu.
- With keys "1" to "6", activate one of the available memory areas.
- Depress the "E"-key. The values can now be edited.
- Enter the desired starting frame rate.
If the digits after the decimal point need not be entered, complete the entry with the "ENTER"-key.
- Enter the desired starting shutter angle.
If the digit after the decimal point needs not be entered, complete the entry with the "ENTER"-key.
- Enter the desired end frame rate.
If the digits after the decimal point need not be entered, complete the entry with the "ENTER"-key.

- Enter the desired end shutter angle.
If the digit after the decimal point needs not be entered, complete the entry with the "ENTER"-key.
- Enter the desired ramp time.
If the digit after the decimal point needs not be entered, complete the entry with the "ENTER"-key.
- Depress the "SEND"-key to transfer the program to the camera.

Note: A program previously stored in the camera will be erased by this process.

Speed Ramping with Exposure Compensation:

Note: This function is not available on the ARRIFLEX 435 as it is not equipped with an electronically adjustable mirror shutter.

In addition to pure speed ramping, exposure compensation is possible. The shutter angle is then linked to the speed ramp for constant exposure.

The CCU-1 offers the possibility to automatically calculate such programs:

- Depress key "7" to change to the PROGRAM menu.
- With key "1" to "6", activate one of the available memory areas.
- Depress the "A"-key to activate the "AUTO" mode.
- Depress the "E"-key. The values can now be edited.

• Enter the desired starting frame rate.

If the digits after the decimal point need not be entered, complete the entry with the "ENTER"-key.

• Enter the desired end frame rate.

If the digits after the decimal point need not be entered, complete the entry with the "ENTER"-key.

Note: A maximum of four aperture stops can be compensated via the shutter angle. The starting and end frame rates may therefore only differ from each other by a maximum of factor 16.

- Depress the "C"-key. Calculation is started.
- The display shows the set frame rates (starting and end) with the corresponding shutter angles, as well as the time which the CCU-1 suggests for the ramp.
- To change the suggested ramp time, depress the "E"-key.
- Confirm frame rates and shutter angles by depressing the "ENTER"-key four times.
- Enter the desired ramp time.
If the digit after the decimal point needs not be entered, complete the entry with the "ENTER"-key.
- Transfer the program to the camera with the "SEND"-key.

Note: A program previously stored in the camera will be erased by this process.

Activating and Running Programs

Note: If the "PROG"-button on the camera is not accessible, the "F4"-key in the REMOTE menu on the CCU-1 can be used as a "PROG"-button.

- Set the NORM/PS switch on the camera to "PS/CCU".
- Activate the program mode with the "PROG"-button on the left side of the camera (the indication "Pr" appears in the camera display).
- Start the camera. The camera runs at the starting frame rate and the corresponding shutter angle.
- Depress the "PROG"-button.
The camera changes its frame rate (and the shutter angle – only 435ES) in the programmed time to the end frame rate (and end shutter angle – only 435ES).
- By again depressing the "PROG"-button the frame rate (and shutter angle – only 435ES) will return to their starting values simultaneously.

Note: To prevent an unintentional alteration the function of "PROG" button can be locked using the sliding switch "LOCK". However this locking does not affect connected accessories such as the CCU-1.

Note: The program itself is stored in the camera and therefore can also be activated if the CCU is not plugged in. As soon as a program is activated, accessories connected to the "ACC" socket will no longer control the camera. At the same time, it is no longer possible to send a new program from the CCU to the camera. Furthermore, the RCU-1 can only be used in the "CAM" Mode.

Displaying Programs which are Stored in the Camera

- Depress the "PROG"-button to activate the stored program.
- Depress the "MODE"-button six times (or four times if no functional expansion module is attached) to change to Mode 7.
- The display shows an angle symbol and the starting shutter angle in the upper line. In the lower line the starting frame rate is shown.
- Depress the "SEL"-button.
- The display shows an angle symbol and the end shutter angle in the upper line. In the lower line the end frame rate is shown.
- Depress the "SEL"-button.
- In the upper line "SEC" is shown, in the lower line the ramp time.

Note: After 3 seconds the display switches back into the start display of mode 7.

The INFO Menu

The INFO menu allows access to the menu points STATUS and COUNTER and enables switching on and off the acoustic signal on the camera control unit.

The 3rd menu point is not available on the ARRIFLEX 435/435ES.

- Select the desired menu point with keys "1" to "2".
- Switch on or off the acoustic signal with key "4".

STATUS

STATUS displays the values currently set on the camera.

COUNTER

COUNTER displays the current values of the total exposed film and take counters as well as the power supply voltage to the camera.

SOUND CCU ON/OFF

The acoustic signal of the CCU can be switched on and off with key "4". When switched on, a test signal sounds.

Remote Control Unit RCU-1

Use of the RCU-1  is only possible in conjunction with the functional expansion module.

The RCU-1 is a practical remote control unit for all new-generation ARRIFLEX cameras, not only for the ARRIFLEX 435/435ES, but also for the ARRIFLEX 16SR 3, 535 and 535B.

It can be used in all applications that call for an uncomplicated, quick, sturdy and yet still comprehensive remote control. An automatic mode enables synchronous control of running speed and shutter opening angle for automatic exposure compensation. Complete programs can easily be created to control changing of frame rate and angle of the mirror shutter over a certain period of time. These programs can be recalled repeatedly as necessary. The RCU-1 automatically calculates the actual screen-time for the programmed speed ramps.

Running values can be regulated with the large handwheel. The free programming of end stops to individually defined minimum and maximum values is particularly comfortable. The illuminated LCD-display quickly, precisely and comprehensively shows all set values as well as the status of the camera, or the RCU-1 respectively, including all warning signals.

For further information see the RCU-1 instruction manual.



Laptop Camera Controller LCC

The LCC is a computer program that allows the ARRIFLEX 435, 435 ES, 535, 535B or 16SR 3 to be controlled from a laptop or notebook computer. The LCC is available for Macintosh PowerBooks (Series 100, 200, 500) and for Windows PC's. An easily understandable user-interface  provides access to all camera status information and enables setting operational parameters, as well as time code time and user bits. Additionally, the LCC can be used to log film stock and to create camera reports.

Monitoring/Controlling

- Frame rate and shutter angle can be precisely controlled. Often used values can be stored in a menu.
- Frame rate changes in any number of steps can easily be programmed and stored. The LCC automatically computes the screen time, the shutter angles necessary for exposure compensation and the length of film that will be exposed.
- In conjunction with the iris control unit (ICU), it is possible to run exposure compensated frame rate programs with cameras not equipped with an electronically adjustable shutter.
- For multiple exposures, frame-accurate rewinding is possible.
- Setting time code and camera preferences is simplified.

Accounting

- The film stock accounting functions offer a clear overview of raw stock and exposed film.
- Camera reports can be created and filled in either automatically or manually. For each take, information such as frame rate, shutter angle, take length, frame numbers, time of day or time code data can be automatically recorded in the camera report. This can then be printed or exported as a text file.
- A daily film report lists all the footage used according to emulsion number.

For further details, see the information pamphlet.

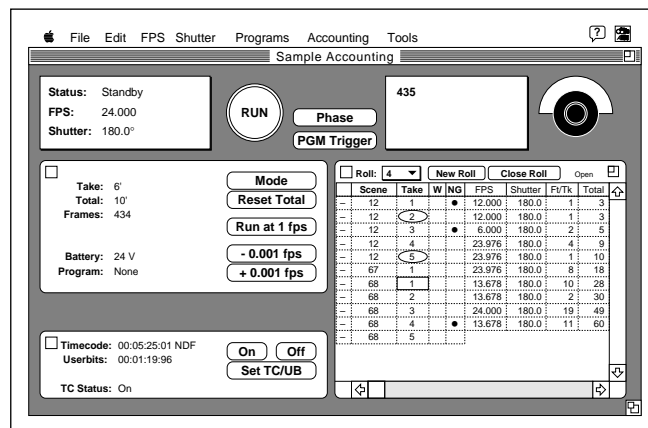

Accessory Socket Distributor (11-pin)

Mounting the Accessory Socket Distributor

- Push the accessory socket distributor ⇨ **photo** onto the 11-pin socket.
- Tighten the fastening screw.

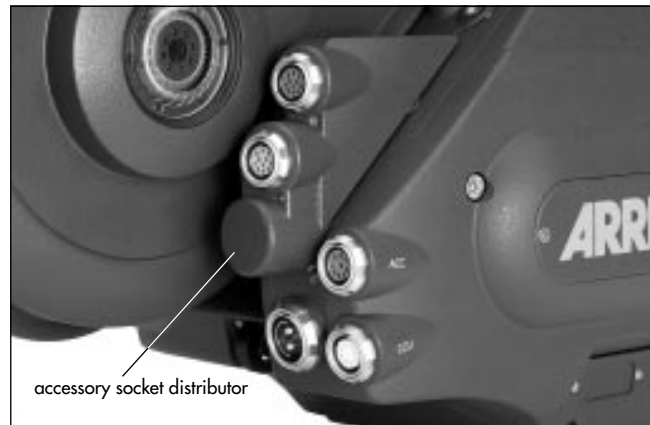

R/S - Socket Distributor (3-pin)

To facilitate operating the camera from the right side, a RUN-button is also integrated into the R/S-socket distributor.

Mounting the R/S Socket Distributor

- Plug the R/S-socket distributor into the R/S-socket ⇨ **photo**.
- Tighten the fastening screw ⇨ **photo**.



*The RS-socket supplies the same voltage as the camera power supply. Voltages over 32 V will be limited to 32 V.
Ensure that the accessories to be used are suited to the available voltage!*





10. Super 35

The Super 35 format offers a range of technical advantages compared to filming with anamorphic lenses:

- a larger selection of available focal lengths,
- smaller and lighter-weight lenses,
- faster lenses,
- shorter lens focus for close-up shots,
- clearly reduced image distortion and geometric aberrations.

In addition, a greater variety of post-production possibilities is available.

For shooting in Super 35, the lens mount receptacle and the upper plate of the bridge plate must be altered for the format. This ensures that the lenses and accessories are exactly aligned to the displaced optical center of Super 35.

Converting the Lens Mount Receptacle to Super 35

For shooting in Super 35, the lens mount receptacle must be turned 180°.

- Remove the six cylindrical screws ⇨ **photo** .
- Unscrew both locking grips ⇨ **photo** .
- Turn the lens mount receptacle so that the number "2" is positioned next to the marking ⇨ **photo** .

- Unscrew the index pin ⇨ **photo** and screw into the opposite inner thread.
- Screw both locking grips firmly into the correct operating position ⇨ **photo** .
- Replace the six cylindrical screws and screw tight.
- Check the flange focal distance.

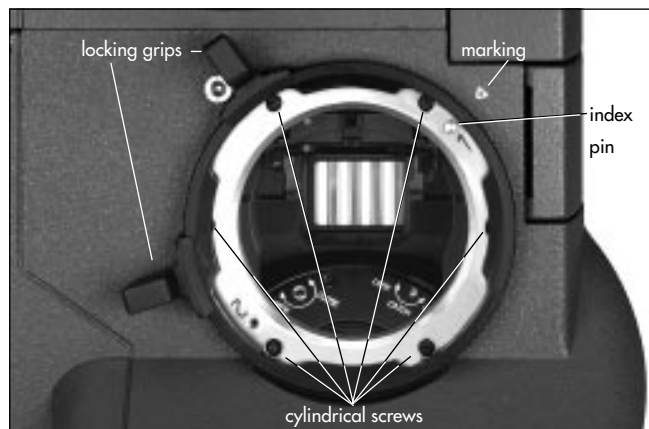

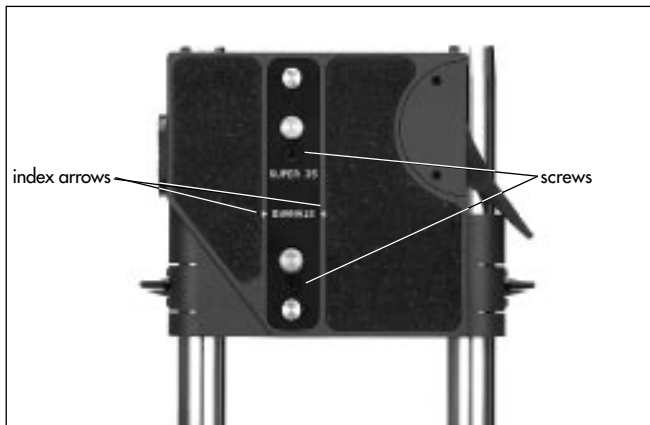

Converting the Bridge Plate to Super 35

The current position, standard or Super 35, is displayed by two index arrows on the sliding upper plate. The bridge plate can be converted to Super 35 as follows:

- Remove the two screws → **photo** .
- Turn the compensation bar 180° and screw tightly in this position.

Note: The viewfinder system is so designed that no alteration is necessary for shooting in Super 35.

For instructions on inserting format masks into the film gate for Super 35, see *Chapter 5, Camera Body, Film Gate*. Regarding illuminated format markings for this format, see *Chapter 6, Optics, Viewfinder System, ARRIGLOW*.

11. Time Code

In modern post-production, time code (TC) is finding increased application. The precise correlation of the film, sound and video recordings is made possible by the use of equipment with time code capability.

The ARRIFLEX 435/435ES is prepared for recording time code onto film. It is only necessary to fit the TC-recording module in place of the film recognition module and to attach the functional expansion module.

Time code is exposed onto the film in accordance to SMPTE guidelines RP 135 and RP 136, Form C.



For recording time code, only the new magazines (ARRIMAG) may be used on the ARRIFLEX 435. With the ARRIFLEX 35 III or 35 II magazines no time code can be recorded!

Time Code Frame Rates

Recording time code is only possible at the following frame rates in forward operation:

23.976 fps

24.000 fps

25.000 fps

29.970 fps

30.000 fps

At other frame rates time code will not be recorded.

However, the time code generator on the camera continues counting with the last set time code frame rate. If the camera is later set back to a time code frame rate, time code will again be available.

At 29.970 fps and 23.976 fps the time code frame rate will be counted in the "Nondrop-Frame" mode adapted to NTSC-video. Time in the "Nondrop-Frame" mode runs exactly 0.1% slower than real time.

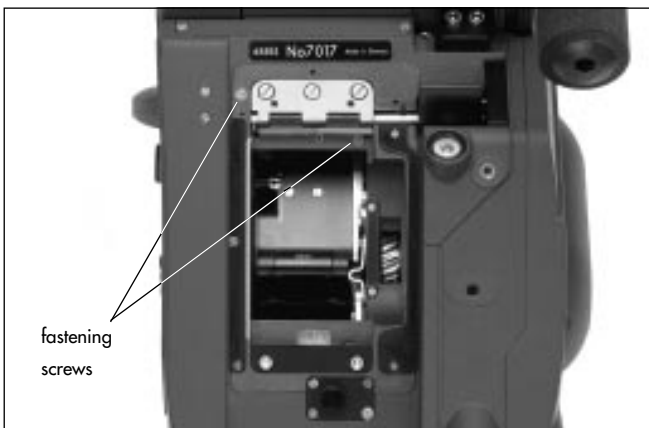
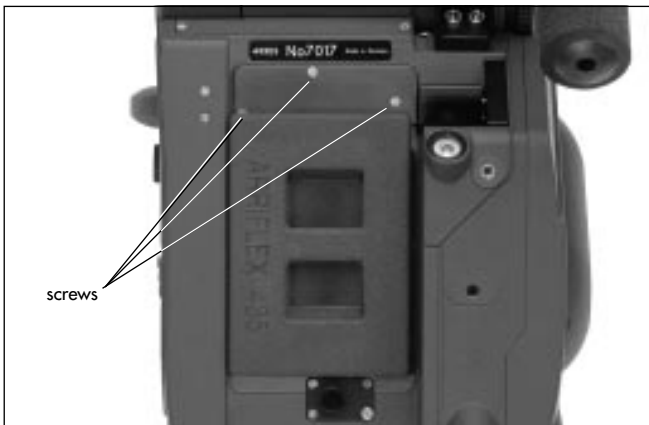

Mounting the Time Code Module

- Switch off the camera's main switch and disconnect the camera from the power supply.
- Unscrew the three screws from the cover of the magazine locking mechanism ⇨ **photo** .
- Remove the cover of the magazine locking mechanism.



Hold the film recognition module firmly so that it does not fall on the movement block and damage the film guides.

- Unscrew both fastening screws ⇨ **photo** .
- Remove the film recognition module ⇨ **photo** in the direction of the movement block.



When installing the module, make certain that the plug is correctly seated, otherwise the plug contacts may be damaged.

- Attach the time code module ⇨ **photo** .
- Tighten both screws ⇨ **photo** .
- Replace the cover of the magazine locking mechanism and tighten with the three screws ⇨ **photo** .

After switching on the camera, the time code frame rate and time code must be set.

Checking the Loop Length



The upper film loop must lie within the marking otherwise the time code recording position will not have the correct relation to the image.

- Set the knurled knob ⇨ **photo** to “LOADING POSITION”.
- The upper film loop must lie within the marking ⇨ **photo** .

Note: For instructions on setting the loop length see *Chapter 5, Attaching the Magazine, Threading the Movement*.

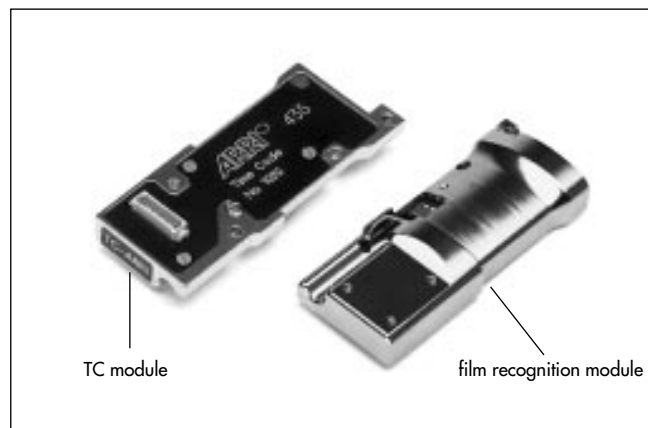

Filmstock		TCS-value
Agfa PAN 250	(B/W-Neg.)	7
Agfa XT 100	(Color-Neg.)	6
Agfa XTR 250	(Color-Neg.)	5
Agfa XTS 400	(Color-Neg.)	5
Fuji 8510	(Color-Neg.)	7
Fuji 8520	(Color-Neg.)	5
Fuji 8521	(Color-Neg.)	7
Fuji 8530	(Color-Neg.)	6
Fuji 8531	(Color-Neg.)	7
Fuji 8550	(Color-Neg.)	4
Fuji 8551	(Color-Neg.)	6
Fuji 8560	(Color-Neg.)	6
Fuji 8561	(Color-Neg.)	5
Fuji 8570	(Color-Neg.)	6
Kodak 5222	(B/W-Neg.)	8
Kodak 5231	(B/W-Neg.)	8
Kodak 5239	(Color-Rev.)	6
Kodak 5240	(Color-Rev.)	5
Kodak 5245	(Color-Neg.)	7
Kodak 5247	(Color-Neg.)	6
Kodak 5248	(Color-Neg.)	7
Kodak 5293	(Color-Neg.)	6
Kodak 5294	(Color-Neg.)	5
Kodak 5296	(Color-Neg.)	5
Kodak 5297	(Color-Neg.)	5
Kodak 5298	(Color-Neg.)	4

Setting Film Sensitivity (TCS-Value)

In order to attain optimal readability of the recorded time code, the brightness of the recording LED must be adapted to the film stock being used.

The time code sensitivity (TCS-value) of various film stocks is listed in the following table.

The corresponding TCS-value is set on the camera.

Setting the TCS Value (Mode 6)

- Depress the "MODE"-button five times to change from Mode 1 to Mode 6.
- Depress the "SEL"-button four times; an "S" appears in the lower line and the next digit blinks.
- Depress the "SET"-button repeatedly until the desired value appears.
- Confirm the entry with the "SEL"-button

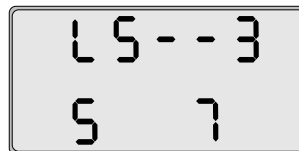

Displaying the TCS-Value (Mode 6)

- Depress the "MODE"-button five times to change from Mode 1 to Mode 6.
- The TCS-value appears in the second line of the display with values of 1 to 9.

Note: The TCS-value must be set beforehand for the film stock used.

Time Code Input

Setting Time Code Time and User Bits

The time code generator (TCG) which is integrated into the functional expansion module can be set via the CCU-1, the LCC or an external LTC-source. The following section describes the setting of TC-time and user bits via the camera control unit CCU-1.

See also *Chapter 9, Camera Control Unit CCU-1*.

Setting Time Code Time with the CCU-1:

- Depress key "5" to change to the time code menu.
- Depress key "1" – "TIMECODE" is displayed against a dark background.
- Depress the "ENTER"-key – the camera control unit is ready for input of the new TC-time.
- Enter a TC-time value within the acceptable range of 00:00:00 to 23:59:59 – the new TC-time is displayed. Confirm the input by depressing the "ENTER"-key; all unfilled digits will default to zero.
- Transfer the new TC-time to the camera with the "SEND"-key.
- Depress the "EXIT"-key to return to the main menu.

Changing Time Code User Bits with the CCU-1:

Normally the date and camera number are entered as user bits: e.g. 290895C1. This ensures clear identification of the film stock on productions lasting several days. However, it is possible to use letters (A to F) and numbers (0 to 9) as desired.

- Depress key "5" to change to the time code menu.
- Depress key "2" – "USERBITS" is displayed against a dark background.
- Depress the "ENTER"-key – the camera control unit is ready for input of the new user bits.
- Enter up to 8 user bits with figures 0-9 or letters A-F – the new user bits are displayed. Confirm the input by depressing the "ENTER"-key; all unfilled digits will default to zero.
- Transfer the new user bits to the camera with the "SEND"-key.
- Return to the main menu by depressing the "EXIT"-key.

External Synchronization

The ARRIFLEX 435/435ES can also be synchronized to other time code compatible equipment. For this it is necessary to plug an LTC-signal (longitudinal time code) into either the "CCU"- or the "ACC"-socket. It is possible to use signals from a time code master clock, a time code recorder, a video recorder, another camera or a time code studio supply.

A suitably configured cable (available through an ARRI service center) and an LTC-signal level of $> 500 \text{ mV}_{\text{pp}}$ are necessary.

If the time code cable with the correct LTC-signal is connected to the "CCU"- or "ACC"-socket, time code time and user bits will automatically be taken on by the camera.

Synchronization can be checked in Mode 4 on the camera display: when the LTC-signal is plugged in, a blinking "EC" (external code) will be displayed in the last two display digits instead of the time code frame rate. When the information has been correctly transferred, the display "CC" (code correct) will appear at the same position for 10 seconds. After this the time code frame rate will be displayed again.

Note: For external synchronization, both pieces of equipment to be synchronized must be running at the same speed.



Displaying Time Code and User Bits

Displaying Current Time Code Time (Mode 4)

- Depress the "MODE"-button three times to change from Mode 1 to Mode 4. Time code time will be displayed with "Hours : Minutes" in the first line and "Seconds : Frames" in the second line of the camera display.

Correlation:	Frame Rate	"Frames"
	23.976	23
	24.000	24
	25.000	25
	29.970	29
	30.000	30

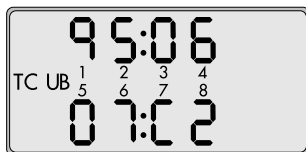

Displaying Time Code User Bits (Mode 5)

- Depress the "MODE"-button four times to change from Mode 1 to Mode 5. User bits will be displayed in the first and second lines of the camera display. Setting user bits is only possible via the CCU, the LCC or external synchronization.

Switching On and Off the Time Code Recording

Before switching on time code recording, the TCS-value must be set (TCS-value > 0).

Switching on Time Code (Mode 4)

- Depress the "MODE"-button three times to change from Mode 1 to Mode 4.
- Hold the "SET"-button depressed for three seconds until the "TC" symbol appears.

Switching off Time Code (Mode 4)

- Depress the "MODE"-button three times to change from Mode 1 to Mode 4.
- Hold the "SET"-button depressed for three seconds until the "TC" symbol disappears.

Note: For test purposes, time code recording can be switched on even if no valid time code is set. In this case the acoustic TC warning "TC switched on but not set" will sound see *TC Warnings* at the end of this chapter. It is possible to record a test time code with a non-valid time

Time Code Output

Time code information is available as 80 bit LTC:

- at the CCU-socket in standby and during camera operation with 2.5 V at 600 Ω asymmetric,
- at the ACC-socket in standby with 5 V asymmetric.

Via the LTC-output, other TC-compatible equipment on the set can be synchronized once to the camera's time code or, from the "CCU"-socket, receive constant time code from the camera. The camera then takes on the function of the master clock. Without a constant connection, the equipment should be newly synchronized after approx. 8 hours' operation.

Time Code and the External Synchronization Unit ESU-1

Via the ESU-1, it is also possible to operate the ARRIFLEX 435/435ES synchronously to other equipment (e.g. a television monitor) during TC-operation. Before plugging in the ESU-1, it is necessary to set the camera – and therewith the integrated time code generator – to the expected ESU frame rate. A deviation of maximum $\pm 1\%$ from the time code frame rate is acceptable. If the ESU frame rate varies too much from that of the time code, the time code recording will switch off (the TC-symbol on the camera display goes off). Only when the acceptable speed range has been reached will time code be recorded again.

Note: During simultaneous time code and ESU operation, the counting of the images and of time code can run apart if the source of synchronization does not run at an exact time code rate. This can cause a jump in the time code count.

Time Code Buffer Battery

The internal time code clock on the camera continues running if the camera is switched off (or if the camera is disconnected from the power supply) as long as a time code buffer battery has been inserted into the camera's functional expansion module. Ten hours after time code was last set, time code time will cease to be buffered.

Displaying the Time Code Buffer Battery Voltage (Mode 6)

- Depress the "MODE"-button five times to change from Mode 1 to Mode 6.
- Depress the "SEL"-button once.
- The TC battery voltage is shown in the second line of the display. If the voltage is < 1 V there will be no display.

Note: The voltage should be > 7.5 V as otherwise the TC values will not be stored.

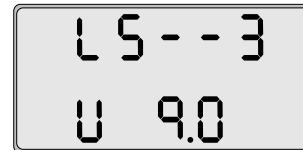

Replacing the Buffer Battery

The buffer battery ⇨ **photo** is a standard 9V battery (we recommend IEC designation GLRG 1, e.g. Duracell MN 1604 or Varta No. 4022) which in normal operation lasts for at least a week.

The buffer battery is located in a compartment on the side of the functional expansion module.

- Switch off the camera's main switch and disconnect the camera from the power supply.
- Completely unscrew the two fastening screws ⇨ **photo** with a screwdriver.
- Remove the cover.
- Remove the battery and unplug.



Pay attention to polarity!

- Plug in a new 9V battery.
- Place the battery into the compartment.
- Replace the cover and screw tight.



Overview of the Display Indications in Time Code Operation

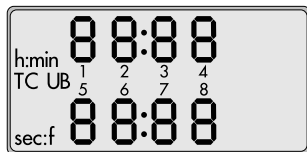

Time code symbol (TC)	Time code is set, and will be recorded when the camera is running.
No Time code symbol (TC)	Time code is off.
Time code symbol blinks in standby	Time code was last set /external synchronization was last carried out over 8 hours ago. Note: If the last setting or synchronization was over 8 hours ago time code can still be recorded for test purposes.
Time code symbol blinks while the camera is running	Time code is not being recorded on the film because of a functional disturbance.

TC-Warnings

A TC warning is displayed firstly as a blinking TC symbol in the camera display. If the warning signal volume on the camera is set to 1 or higher, an acoustic tone will also sound in the same rhythm as the blinking of the symbol when the camera is in standby.

The acoustic warning can be switched off as follows:

- Remedy the cause of the warning.
- Switch off time code.
- Set the warning tone volume to 0 (see under *Switching On and Off the Warning Signal for Asynchronous Running and the Acoustic TC-Warning, Chapter 7*).
- By briefly depressing the "SET"-button in Mode 1 of the display, the acoustic warning can be suppressed for 15 minutes.
- The acoustic TC-warning is automatically switched off as long as the camera is running. After stopping the camera, the warning tone will begin to sound again in standby after approx. 3 seconds.

Additionally, the camera is capable of displaying one or several more detailed warnings in hexadecimal form. Change to display Mode 5 (user bits) with the "MODE"-button and depress the "SEL"-button.

In the upper line four figures or letters will be shown. Their meaning can be looked up in the following table. If there is no warning, the upper line displays **00:00**.

Example: The message 00:03 indicates two warnings:

- error in external synchronization and
 - TC is switched on but not set
- Both warnings can be remedied by external synchronization or by setting TC via the CCU-1.

1st Display-Digit for TC Warnings																Warning	Remedy
0	1	2	3	4	5	6	7	8	9	A	b	c	d	E	F		
	●		●		●		●		●		●		●		●	no valid TC frame rate	set correct TC frame rate or switch off TC
		●	●			●	●				●	●			●	no TC with PROG	switch off TC
				●	●	●	●					●	●	●	●	no TC in REVERSE	switch off TC
								●	●	●	●	●	●	●	●	in the last take no or only intermittent TC	briefly depress the "PHASE"-button, or reshoot

2nd Display Digit for TC Warnings																Warning	Remedy
0	1	2	3	4	5	6	7	8	9	A	b	c	d	E	F		
	●		●		●		●		●		●		●		●	>8 hours since TC last set	reset TC as last setting was over 8 hours ago
		●	●			●	●				●	●			●	TCS value not valid	reset TCS value
				●	●	●	●					●	●	●	●	given ESU frame rate outside TC range	check given ESU frame rate (display Mode 1) and TC generator frame rate (Mode 4); allowable difference of max. $\pm 1\%$
								●	●	●	●	●	●	●	●	no TC with variable speed	switch off variable speed accessory or TC as TC-operation with variable speed is not possible

3rd Display Digit for TC Warnings																Warning	Remedy
0	1	2	3	4	5	6	7	8	9	A	b	c	d	E	F		
	●		●		●		●		●		●		●		●	TC magazine not recognized	use a suitable 435 magazine
		●	●			●	●			●	●			●	●	TC not set to NDF/RT and switched to RT/NDF	reset TC at current frame rate RT (Real Time) is 24, 25, 30 fps NDF (Nondrop Frame) is 23,976 and 29,97 fps
				●	●	●	●					●	●	●	●	TC-LED not recognized	attach or check TC-module
								●	●	●	●	●	●	●	●	TC not buffered	reset TC; either the TC buffer battery is used up or the power supply was insufficient or interrupted, or over 10 hours passed since TC was last set

4th Display Digit for TC Warnings																Warning	Remedy
0	1	2	3	4	5	6	7	8	9	A	b	c	d	E	F		
	●		●		●		●		●		●		●		●	error in external synchronization	repeat external synchronization check LTC-signal
		●	●			●	●			●	●			●	●	TC switched on but not set	set TC via CCU-1, LCC, or external synchronization
				●	●	●	●					●	●	●	●	TC not ready	have functional expansion module (FEM) checked

12. Maintenance

When maintaining and cleaning the camera and accessories, pay careful attention to the following notes and tips:

- Always disconnect the camera from the power supply.
- Clean the camera and accessories only on a clean and flat surface which is covered with foam material or a clean, lint-free cloth.
- Under no circumstances use acetone or nitro-thinner. These chemicals dissolve the paint and can damage highly-polished surfaces.
- For cleaning, it is recommended to use soft, lint-free cloths and swabs. Also suitable are special cleaning tissues and small sponges as used in cleaning computers and video equipment.
- When cleaning the film movement, do not exert too much pressure. Use only the prescribed special tools. Use only screwdrivers of the correct size.
- From time to time – at the latest however after the occurrence of a film jam – it is recommended to clean the entire interior of the camera and also the magazine throat, the film movement and the film gate with a brush. In most cases it is sufficient to vacuum out dust and film chips from the camera and the magazine interiors. A small battery-powered vacuum cleaner, as used in cleaning computers, is suitable for this task.

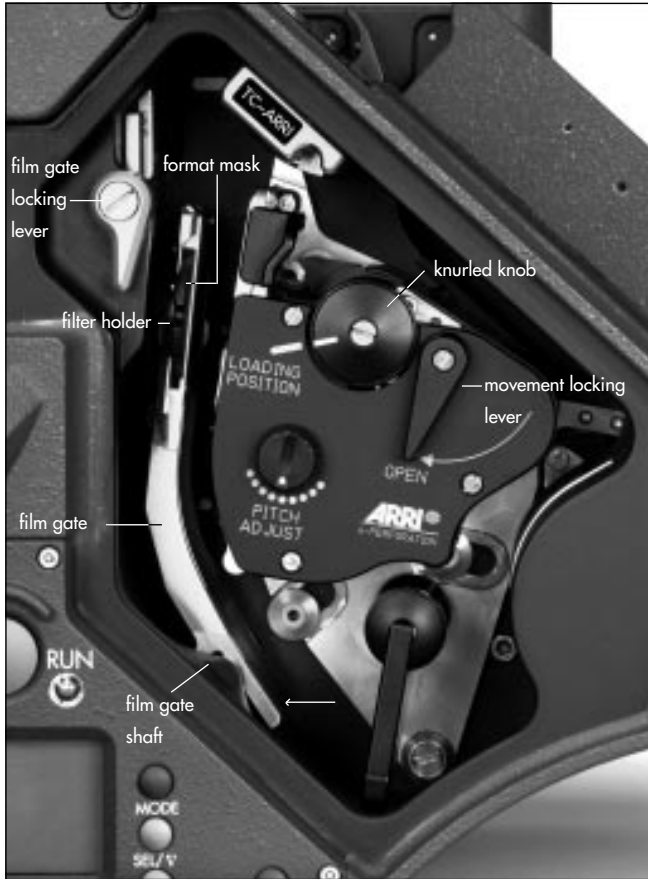

Camera

Cleaning the Film Gate

To avoid a build up of dirt in the image area, the format mask on the ARRIFLEX 435/435ES is set back from the surface of the film gate.

Loose dust or dirt leads to a layer of emulsion forming on the film gate. This can cause scratches on the film and can also lead to a change in the film's coefficient of friction. The film gate must be removed for cleaning.



Attention!

Keep fingers out of the film gate opening as this may dirty or damage the mirror shutter.

To remove the film gate

- Switch off the camera's main switch and disconnect the camera from the power supply before removing the film gate.
- Turn the knurled knob ⇨ **photo** on the movement until its marking matches that on the movement block.
- Turn the movement locking lever ⇨ **photo** towards the "OPEN" position to swing the movement block away from the film gate.
- Press the film gate locking lever ⇨ **photo** towards the magazine throat assembly and swing the film gate ⇨ **photo** towards the movement block, pressing lightly on the lower end of the film gate and taking care that the film gate does not hit the movement block.
- Take hold of the film gate by the filter holder ⇨ **photo**, lift it up and remove.

To clean the film gate

- Remove the layer of emulsion from the film gate with a plastic rod (e.g. an ARRI film gate cleaner). Under no circumstances use hard or metal objects.
- When cleaning, pay particular attention to the area opposite the film guides of the movement if film stock with a strong tendency to build up emulsion (e.g. b/w stock) is being used.

Inserting the film gate



Warning: It is absolutely essential to ensure that the connecting surfaces are free of dust and debris (e.g. film chips) in order to guarantee the accuracy of the film channel.

- Check that the film gate and the film gate shaft are completely free of dust and dirt.
- Take hold of the film gate by the filter holder and place onto the film gate shaft from above.
- Check that the film gate is correctly seated on the shaft.
- Press the film gate locking lever ⇨ **photo** towards the magazine throat assembly and push the film gate forwards to the correct position.
- Ensure that the film gate locking lever ⇨ **photo** swings back completely.



Swinging the movement block forwards when the film gate is not correctly in place can cause damage to the camera!



Cleaning the Spacer Gate

Loose dust leads to a build-up of emulsion on the spacer gate. This can cause scratches on the film and a change in the coefficient of friction.

- Switch the camera's main switch off and disconnect the camera from the power supply!
- Press the safety spring ⇨ **photo** downwards, at the same time pressing the spacer gate backwards by its handle ⇨ **photo**. Then remove by pulling upwards.
- Remove the layer of emulsion from the spacer gate ⇨ **photo** with a plastic rod (e.g. an ARRI film gate cleaner). Under no circumstances use hard or metal objects.
- When cleaning, pay particular attention to the spacer gate if film stock with a strong tendency to build up emulsion (e.g. b/w stock) is being used.
- Take hold of the spacer gate by its handle ⇨ **photo** and insert it at an angle from above into the movement block.
- Push the spacer gate downwards until it locks audibly in place.

Cleaning the Field Lens

- By briefly depressing the “PHASE”-button, the shutter is positioned to protect the mirror surface from damage as far as possible.
- Before cleaning the field lens, switch the camera’s main switch off and disconnect the camera from the power supply!
- Remove the lens or the protective cap.



Do not touch the mirror surface!

- Pull the ground glass ⇨ **photo** out of the holder by its tongue ⇨ **photo** using the special forceps.
 - Push the safety plate ⇨ **photo** upwards with a screwdriver.
 - Pull the field lens ⇨ **photo** out off the holder by its tongue ⇨ **photo** using the special forceps.
 - Clean the field lens with a dry, lint-free cloth.
 - Make sure that the frame is completely clean.
- Using the special forceps, push the field lens as far as it will go into the holder. A ball catch fixes the field lens in the correct position.
 - Push the safety plate ⇨ **photo** down again with the screwdriver.
 - Check if the ground glass to be used and the ground glass frame are completely clean.
 - Using the special forceps, push the ground glass into the holder as far as it will go. A ball catch fixes the ground glass in the correct position.
 - Check that the ground glass is locked in place.

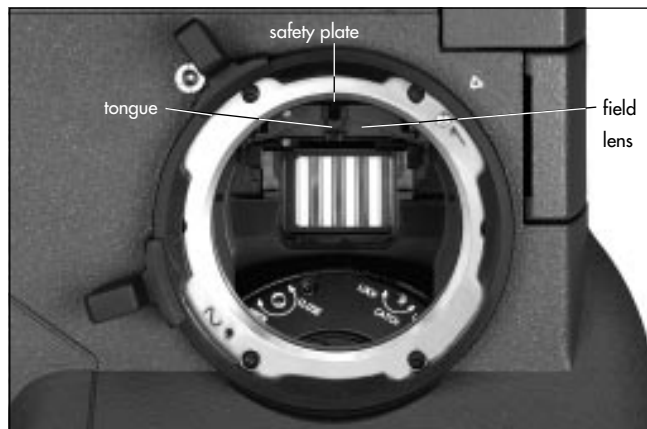

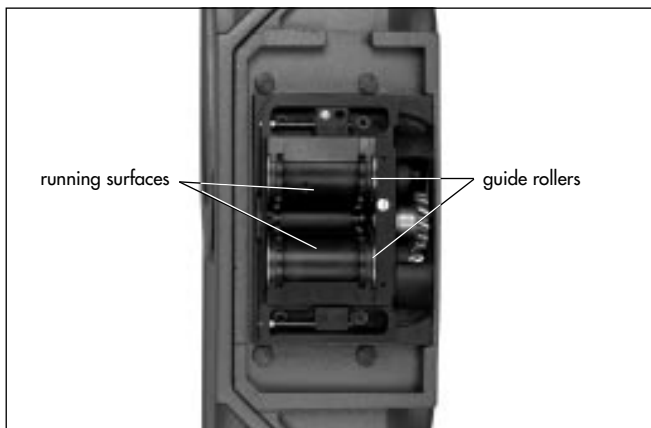
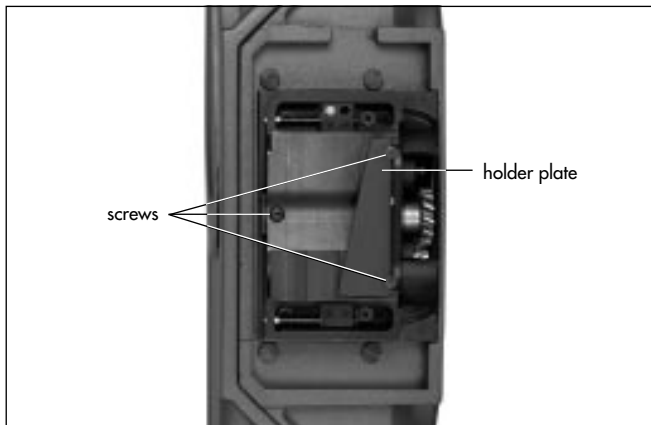

Magazine

Cleaning the Throat Assembly

The throat assembly ⇨ **photo** can be disassembled for cleaning.

- Loosen the three screws ⇨ **photo** on the throat assembly cover ⇨ **photo**.
- Remove the holder plate ⇨ **photo** for the loop protector.
- Pull out the throat assembly cover.
- Clean the film running surfaces ⇨ **photo** and guide rollers ⇨ **photo** with a brush.
- Put the throat assembly cover back in place.
- Replace the holder plate for the loop protector and re-tighten the throat assembly cover with the three screws.

Setting Friction on the ARRIMAG 120

- Swing both roller arms ⇨ **photo** away from the winding shafts until they lock in place.
- Unscrew the three screws on the transparent tensioning plate ⇨ **photo**.
- Remove the plate.
- Place film cores on both winding shafts.
- Place the tension measurement device ⇨ **photo** on the film core which will not be measured.
- Hang the hook of the measurement device ⇨ **photo** on the film core which is to be measured.
- Attach the open magazine to the camera.



Do not place your hand in the running magazine!

- To set the take-up shaft, run the camera at 24 fps. For setting the tension of the feed shaft, the camera must run at 24 fps reverse. The tension measurement device should be showing ring "5".
- If the tension measurement device is not showing "5", stop the camera.
- Switch off the camera's main switch and disconnect the camera from the power supply.
- Place the special key ⇨ **photo** in the holes of the friction adjustment and turn in steps. The adjustment must lock in at each step. When setting friction, the corresponding winding shaft must be held firmly.
- Turn clockwise to increase friction, counter-clockwise to decrease friction.
- Connect the camera to the power supply and switch on.
- Run the camera at 24 fps.
- Check the tension.

Note: Repeat this procedure until ring "5" is shown.

- After setting the friction, replace the tensioning plate.
- Fasten the plate with the three screws.





Appendix

The frame rate of the camera is constantly monitored while it is running. If the actual frame rate deviates from the set frame rate, the operation control indicator glows red and the camera display shows the warning for asynchronous running ("asy").

The synchronization of the shutter and the movement is also monitored. Should an undue deviation in the synchronization occur, the camera will stop. The display will show "asy". This monitor function is built into the electronic control of the drive system.

As an additional security feature for the user, a second, independently operating monitor system for the shutter/movement synchronization is integrated into the camera electronics. If this additional circuit stops working while the camera is running, the display will show a warning after the camera is stopped. The operation control indicator will remain red, the camera cannot be re-started and must be checked by an ARRI service center.

This display only indicates that the additional monitor system is defective.



If the warning "Monitoring Defective" is overridden, an additional fault in the electronic control of the drive system will not be detected and may cause faulty exposure!

Display: Monitoring Defective

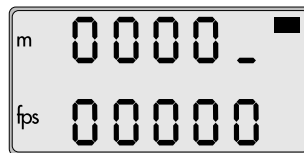

Note: The warning "Monitoring Defective" can be overridden by switching off and on the camera's main switch.

Loose Film Loops in the Magazine

If the camera shuts off automatically while running, loose film loops may be formed in the magazine. Before the camera is started again, the film in the magazine must be tensioned manually.

Fuses

The ARRIFLEX 435/435ES is equipped with self-resetting automatic fuses. It is therefore not necessary to replace blown fuses.

Problem	Cause	Remedy
Scratches on the emulsion side of the negative		
In the image area, over several frames	Dirty or damaged cross bars on the film gate	Clean or, if defective, replace the film gate or format mask
In the image area, short and periodically recurring (above and below)	Upper or lower film loop too long, film touches inside of camera housing	Check the position of the upper loop in relation to the marking Check the loop length of the magazine
Outside the image area	Dirty or damaged longitudinal bars on the film gate or film running surfaces in the magazine throat	Carefully clean film gate and magazine throat or, if defective, replace
Scratches on the glossy side of the negative		
In the image area	Dirty or damaged film track or spacer gate	Clean film track (movement) and spacer gate or, if defective, replace
Outside the image area	Dirty or damaged longitudinal bars on the film track or film running surfaces in the magazine throat	Carefully clean longitudinal bars and magazine throat or, if defective, replace
Scratching in general	Strong tendency of raw film stock to build up emulsion, dust on raw stock from perforation process, extreme temperatures, scratched raw stock	Complain to the manufacturer of the film stock, use different film stock

Problem	Cause	Remedy
Unsteady Image		
Vertical	Heavy emulsion build-up in the film gate area, damaged film perforation, very poor gliding ability of the raw film stock, film stock with positive perforation, dimensions of raw stock not within tolerance	Clean film gate area, use different film stock
Horizontal	Heavy emulsion build-up in the film gate area, film edge is not straight	Clean film gate area, use different film stock
Pressure exposures around perforation holes	Mechanical stress on the perforation holes	Pressure exposures do not effect the image steadiness
Image Problems		
Blurred image	Flange focal distance is incorrectly set, lens is incorrectly set, poor quality or defective lens, film gate is not properly locked into position	When cleaning or exchanging the film gate ensure that the surfaces are absolutely clean, check the lens and the flange focal distance

Problem	Cause	Remedy
Problems at extremely low temperatures		
Damage to the film	<p>Greatly reduced tensile strength and increased brittleness of raw stock.</p> <p>In temperatures under - 15 °C (5° F) especially, a change in the film's friction properties occurs.</p>	<p>The camera, battery and particularly the film stock must be protected from extreme cold.</p> <p>When a cold camera is brought into a warm and humid room, condensation builds up.</p> <p>This can be prevented by interim storage of the equipment at approx. 0°C (32°F).</p>
The camera does not reach the selected frame rate	Capacity or voltage of the battery is insufficient	<p>Check the battery charge following the directions in the instruction manual.</p> <p>Check that the camera movement turns easily by turning the knurled knob on the movement manually.</p> <p>If difficult to turn, let the camera run for a few minutes without film.</p> <p>Check that the magazine turns easily.</p>
Problems in extremely high temperatures		
Increased emulsion build-up	<p>The mechanical properties of the film change considerably at temperatures of over 30 °C (86°F).</p> <p>The film becomes soft and easily deformed.</p> <p>The friction coefficient changes and the film builds up more emulsion.</p>	Protect the camera and the film stock from extreme heat, e. g. by shading or white covering etc.

Technical Data

Film Format

35mm (DIN 15501)

Magazines

ARRIMAG 120 forwards/reverse up to 150 fps

ARRIMAG 120S forwards/reverse up to 150 fps

ARRIMAG 300E forwards/reverse up to 150 fps

Recording of TC is possible with these magazines.

All ARRIFLEX 35 III and 35 II magazines

with exception of the shoulder magazine;

150m magazine forwards/reverse up to 130 fps

60m and 300m magazine forwards up to 130 fps

Recording of TC is not possible with these magazines.

Lens Mount

54mm PL-mount (positive locking)

Convertible for Super 35

Flange Focal Distance

51.98-0.01mm

Mirror Shutter ARRIFLEX 435

Can be adjusted mechanically from 11.2° - 180°

and locks in the following positions:

11.2°, 22.5°, 30°, 45°, 60°, 75°, 90°, 105°, 120°, 135°, 144°, 172.8° and 180°.

Mirror Shutter ARRIFLEX 435ES

Continuously adjustable from 11.2° - 180°

in standby or while running.

Movement

5-link highspeed movement

with dual-pin registration

and dual three-pin pull-down claws

for 35mm negative film (DIN 15501);

equipped with ball bearings for low maintenance.

Speed Range

1-150 fps forwards and reverse (quartz stabilized)

adjustable to 0.001 fps for frame rates up to 100 fps

adjustable to 0.01 fps for frame rates over 100 fps

Viewfinder

Adjustable in two axes with automatic image compensation and additional manual image compensation.

Warning for asynchronous film running is reflected in.

Available as an option, the ARRIGLOW provides an illuminated frame with continuously adjustable brightness and warnings for ASY, BAT and END.

Ground Glasses

Interchangeable for various filming formats

Acceptable Temperature Range

-20°C to +50°C (-4°F to +122°F)

Power Supply

Up to 130 fps 24 V DC

Above 130 fps ≥24 V DC

Acceptable voltage range: 20.6...35 V DC

Function Monitoring

Power supply voltage (BAT)

Synchronous running (ASY)

Time code recording (TC)

Display of time code information

Time Code

The time code generator that is integrated into the functional expansion module generates 80 bit time code in

accordance to SMPTE RP136, Form C.

Time code quartz accuracy:

± 1 frame in 8 hours at 0°C to 50°C (32°F to 122°F)

Dimensions

Length with 120m magazine without lens: 400mm (15 1/2")

Width with viewfinder on the left: 250 mm (10")

with viewfinder on the right: 300mm (12")

Height with grip: 270mm (10 1/2")

without grip: 230mm (9")

Weight

Camera without magazine, without lens:

ARRIFLEX 435: 6.45 kg ... (14.2 lbs)

ARRIFLEX 435ES: 6.77 kg ... (14.9 lbs)

(including functional expansion module)

Order Numbers

ARRIFLEX 435	K0.59991.0
ARRIFLEX 435ES	K0.59992.0
ARRIFLEX 435, anamorphic viewfinder	K0.59993.0
ARRIFLEX 435ES, anamorphic viewfinder	K0.59994.0

Installation of the Camera

ARRIHEAD 2	K2.43670.0
Hydrohead Studio 80 II M	K2.45348.0
Hydrohead 150 H	K2.50491.0
Wedge plate	K2.47092.0
Lens support LS-7, ø 19mm	K2.42538.0
Lens support LS-8, ø 15mm	K2.49012.0
Shoulder set S-4 (without shoulder cushion)	K2.47093.0
Shoulder cushion	K4.46446.0
Bridge plate BP-8, ø 19mm	K2.47090.0
Bridge plate BP-9, ø 15mm	K2.47091.0
Support rods 240mm, ø 19mm	K2.43046.0
Support rods 240mm, ø 15mm	K2.21958.0
Support rods 340mm, ø 19mm	K2.47347.0
Support rods 340mm, ø 15mm	K2.47348.0

Power Supply

Battery NC 24/7 R	K2.41950.0
HS supply module CHS-1	K2.52002.0
Battery cable KC 20S	K2.41966.0
Charger NCL 24 R	K2.42010.0
Mains unit NG 12/24 R	K2.44481.A
Mains unit NG 12/26 (4-pin)	K2.47352.0
Mains unit NG 12/26 (5-pin)	K2.47351.0
Spiral battery cable KC 29S	K2.44693.0

Magazines

ARRIMAG120 120m / 400 ft magazine	K2.47083.0
150 m / 500 ft magazine (ARRIFLEX 35 III)	K2.15700.0
300 m / 1000 ft magazine (ARRIFLEX 35 III)	K2.17800.0
Tool set for adjusting magazine friction	K2.26100.0

Optical Accessories

Follow focus FF-3	K0.59973.0
3" x 3" light-weight matte box LMB-2	*K0.59954.0
4" x 4" light-weight matte box LMB-3	*K2.44471.0
4" x 4" production matte box MB-16	*K2.44472.0

4" x 5.65" production matte box MB-18	*K2.47178.0
4" x 5.65" production matte box MB-19	*K2.47099.0
5" x 6" production matte box MB-15	*K2.44473.0
6.6" x 6.6" production matte box MB-14	*K0.59971.0
Heated eyecup HE-3	K2.47097.0
Cable KC-42 (for RS socket)	K4.47473.0
Cable KC-26 (for accessory socket)	K4.44093.0
Finder extender FE-3	K2.47082.0
Super wide-angle eyepiece (10x)	K2.41822.0
Wide angle eyepiece (8x)	K2.47081.0
Anamorphic viewfinder AVF-2	K2.47084.0

* These order numbers refer to matte boxes for ø 19mm support rods

Accessories

Functional expansion module FEM	K4.52136.0
ARRIGLOW module	K2.47088.0
Extra handgrip	K4.46680.0
Camera control unit CCU-1 with cable	K2.42320.0
External synchronization unit ESU-1	K2.46006.0
Remote switch RS-4	K2.46942.0
Remote control unit RCU-1	K2.47197.0
Work light WL-3	K2.47098.0
Iris control unit (ICU)	K2.47028.0
Zoom control set (LCS)	K2.41377.0
Focus /iris control unit (FIU-1)	K2.41383.0

Laptop Camera Controller (LCC) software	K2.47119.0
Accessory socket distributor (11-pin, 12V)	K2.52003.0
RS-socket distributor (3-pin, 24V)	K2.52001.0
Accessory set 435	K4.52094.0

Video

Video optic VO-2	K2.47086.0
1/2" colour video camera CCD-2-FR, NTSC	K2.45866.0
1/2" colour video camera CCD-2-FR, PAL	K2.45865.0
Anti flicker processor AFP-2, NTSC	K2.43195.0
Anti flicker processor AFP-2, PAL	K2.43194.0
Beamsplitter 50/50	K2.47089.0

Time Code

SMPTE Time code module	K2.52000.0
------------------------------	------------

Index

12 V accessories	22	11-pin	22
24 V accessories	23	RS-socket	23
9 V battery	1.1.1	accessory socket distributor (11-pin)	9.7
A		acoustic warning	
ACC socket	80, 107, 109	<i>setting warning signals</i>	68
acceptable temperature range	1.28	<i>switching off TC-warning</i>	112
accessories	7.5.	activating and running programs	9.3
12 V	22	AFP-2	69, 71, 72
24 V	23	anamorphic viewfinder AF-2	7.5
anamorphic viewfinder AVF-2	75	angle adjustment	3.1.
camera control unit CCU-1	82	anti-flicker processor AFP-2	69
external synchronization unit ESU-1	81	<i>mounting AFP-2</i>	71
functional expansion module FEM	80	aperture of video optic	7.2
heated eyecup HE-3	79	appendix	1.23
iris control unit ICU	96	ARRIGLOW	5.4.
laptop camera controller LCC	96	<i>adjusting brightness</i>	5.4
R/S - socket distributor	97	<i>attaching</i>	5.4
remote control unit RCU-1	95	<i>exchanging the format mask</i>	5.5
remote run switch RS-4	79	ARRIMAG 120	2.5, 127
video viewfinder VT-2	77	<i>loading</i>	26
work light WL-3	78	ARRIMAG 120S	2.5, 127
accessory power supply	2.2	ARRIMAG 300E	2.5, 127
accessory socket		AVF-2	7.5.
		AVF-2 anamorphic viewfinder	7.5

B	
balancing the camera.....	13
batteries, replacing	
CCU-1	83
TC-buffer battery.....	111
battery cable KC 20S.....	20, 21, 22
battery NC 24/7 R.....	20
beamsplitter.....	50, 69
beamsplitter ratios.....	50
BP-8	12
BP-9	12
bridge plate	
<i>attaching to camera</i>	13
BP-8, BP-9.....	12
<i>converting to Super 35</i>	100
buffer battery, replacing.....	111
buttons	
MODE	59, 86
PHASE	59, 64, 67, 86, 93
PROG	59, 86, 93
RUN	58, 60
SEL	59, 93
SET	59, 86, 93
C	
C-mount	71
cable	
KC 20S.....	20, 21, 22
KC 24S.....	83
KC 29S.....	20, 21, 22
KC 30S.....	83
KC 34.....	72
KC 36.....	72
KC 37.....	72
KC-26S.....	79
KC-42S.....	79
camera	
camera body	31
camera number as user bits	106
installation	11
main switch	57
operation	57
starting.....	58
stopping.....	58
testing without magazine.....	30
camera control unit CCU-1.....	80, 82
activating and running programs	93
ASYNC-MODE.....	88
batteries, replacing	83
connecting.....	83
COUNTER	94

COUNTER DISPLAY MODE	88	charger NCL 24 R.....	20
displaying programs stored in the camera	93	CHS-1	19, 21
error displays	84	CID-discharge lamps.....	37
INFO menu	94	continuous current.....	22, 23
key functions	83	contrast filter.....	53
LENGTH-UNIT	88	cover	
main menu	84	for lens mount receptacle	5
OPTIONS-menu	88	for magazine opening	30
PROG-button	93	for video optic	70
PROGRAM menu	89	D	
ramping with the ARRIFLEX 435	90	darkroom.....	26
ramping with the ARRIFLEX 435ES	91	dimensions	128
REMOTE menu	86	diopter adjustment.....	51
SHUTTER menu	86	display	62
SOUND CCU ON/OFF	94	CC (code correct)	107
SPEED menu	84	configuring Mode 1, ARRIFLEX 435ES	64
speed ramping with exposure compensation	92	display lock	59, 93
speed ramping with the ARRIFLEX 435	90	display: movement open	62
STATUS	94	displays in time code operation	112
time code time, changing	87	displays in viewfinder	50
TIMECODE menu	87	EC (external code)	107
user bits, changing	87	film counter	63
camera report	96	Mode 1	59, 60, 63, 64, 65
CC (code correct).....	107	Mode 2	60, 65, 66
CCU socket.....	80, 107, 109	Mode 3	60, 63, 67
CCU-1	82	Mode 4	60, 108, 109
changing bag.....	26		

Mode 5	60, 108	eyecup	79.
Mode 6	60, 68, 105, 110	eyepiece.....	51.
Mode 7	60	<i>adjusting friction</i>	52
monitoring defective	123	<i>adjusting the diopter</i>	51
overview of display modes	60	<i>attaching</i>	51
shutter angle	64	<i>removing</i>	51
symbols	61	F	
take length	63	FEM	80.
TC-symbol.....	109	field lens, cleaning.....	119
total amount of exposed film	63	film	
dovetail-adapter.....	71, 78	<i>changing bag</i>	26
E		<i>loading ARRIMAG 120</i>	26
EC (external code)	107	<i>threading the movement</i>	43
electronically adjustable shutter		film counter.....	63.
<i>checking the locking mechanism</i>	35	<i>changing unit of measurement (meters/feet)</i>	63
<i>switching off</i>	36	<i>configuring</i>	63
<i>switching on</i>	36	<i>displaying film counting values</i>	63
emulsion build-up		<i>resetting</i>	63
<i>film gate</i>	116	film cutting gauge.....	26
<i>spacer gate</i>	118	film format	127
ESU-1	80, 81, 110	film gate	39.
exposure compensation.....	92	<i>changing the format masks</i>	39
<i>automatic</i>	95	<i>cleaning</i>	116
external standard video signal.....	81	<i>inserting filters</i>	41
external synchronization unit ESU-1	80, 81, 110	film gate cleaner.....	117, 118
external time code synchronization.....	107	film recognition module.....	101, 102

film stock accounting.....	96
filter	
<i>filter foils</i>	41
<i>filter holder</i>	41
<i>inserting in film gate</i>	41
fine-tuning the programmed frame rate.....	66
flange focal distance.....	127
focus of the video optic.....	72
format masks, changing.....	39
forward operation.....	66
frame rate	
<i>changing while camera is running</i>	66
<i>fine-tuning</i>	66
<i>freely programmed frame rate</i>	65
<i>setting and storing</i>	64
<i>shifting phase</i>	67
<i>standard frame rate</i>	65
friction	
<i>eyepiece</i>	52
<i>viewfinder arm</i>	52
friction of ARRIMAG 120, adjusting.....	120
function monitoring	128
functional expansion module FEM.....	80
<i>interfaces</i>	80
fuses	123

G

gelatine filters	4.1.
GEN-LOCK input	69.
general description.....	9..
grip system	1.5.
<i>attaching additional handgrips</i>	15
<i>removing</i>	15
ground glasses	128
<i>exchanging</i>	38
<i>frame</i>	38
<i>special forceps</i>	38

H

handgrips.....	1.5.
HE-3	7.9..
heated eyecup HE-3.....	7.9
helicopter mount.....	1.1.
highspeed power supply.....	1.9, 21
HMI light.....	3.7.
HMI/CID-discharge lamps.....	3.7
HS supply module CHS-1.....	2.1

I

ICU	9.6..
illuminated format markings	5.4
<i>attaching ARRIGLOW module</i>	5.4
<i>exchanging the format mask</i>	5.5

image compensation.....	53
<i>automatic</i>	53
<i>inverting the image</i>	53
<i>manual</i>	53
<i>reactivating automatic image compensation</i>	53
image position	
<i>adjusting on video optic</i>	72
<i>inverting the viewfinder image</i>	53
inching	59.
installation	1.1.
iris control unit ICU	9.6
L	
laptop camera controller LCC.....	80, 96
LCC.....	80, 96
length unit (meters/feet), changing.....	63
length unit (meters/feet), changing with CCU-1.....	88
lens mount	49, 127
lens mount, converting to Super 35	99
lens support ring	14.
lenses	49.
<i>attaching</i>	49
<i>lens support LS-7</i>	14
<i>lens support LS-8</i>	14
<i>support</i>	14
LOCK sliding switch.....	59, 93
loop protector.....	1.1, 26, 30

loose film loops in the magazine.....	123
LTC, 80 bit.....	109
LTC output.....	109
LTC signal.....	107

M

Macintosh PowerBook.....	96
magazine	25, 127
<i>ARRIFLEX 35 III magazines</i>	25
<i>ARRIMAG 120</i>	25, 127
<i>ARRIMAG 120S</i>	25, 127
<i>ARRIMAG 300E</i>	25, 127
<i>attaching</i>	43
<i>film tension, measuring</i>	120
<i>friction of ARRIMAG 120, adjusting</i>	120
<i>loading</i>	26
<i>loose film loops</i>	123
<i>magazine throat, cleaning</i>	120
<i>removing</i>	47
<i>removing exposed film</i>	29
<i>roller arms</i>	26
<i>safety catch</i>	26
<i>tensioning plates</i>	29
<i>transport and storage</i>	30
magazine throat, cleaning.....	120
mains unit NG 12/24 R.....	2.1
mains unit NG 12/26 R.....	2.2

maintenance	1.15	<i>display: movement open</i>	62
MINI MONITOR-socket	72	<i>pitch adjustment</i>	46
mirror shutter	31.	<i>technical data</i>	127
<i>angle measurement</i>	33, 36	MOVIE CAMERA-socket	72
<i>displaying shutter angle</i>	64	multiple exposures with frame-accurate rewinding	96
<i>electronically adjustable</i>	34	N	
<i>angle adjustment</i>	35	nondrop-frame mode	101
<i>checking the shutter locking mechanism</i>	35	NORM-position	64.
<i>switching off</i>	36	NORM/PS-switch	66.
<i>switching on</i>	36	O	
<i>mechanically adjustable</i>	31	operational parameters	
<i>angle adjustment</i>	31	<i>displaying and setting</i>	59
<i>shutter angle stops</i>	31	optics	49.
<i>position "LOCK"</i>	32	order numbers	129
<i>position "LOOSE"</i>	32	overload display	23.
mirror shutter ARRIFLEX 435	127	P	
mirror shutter ARRIFLEX 435ES	127	packing and transport	1.1
Mode 1	59, 60, 63, 64, 65	peak load, current	22, 23
<i>configuring, ARRIFLEX 435ES</i>	64	phase shifting	67.
Mode 2	60, 65, 66	PHASE-button	59, 64, 67, 86
Mode 3	60, 63, 67	pickup	8.1.
Mode 4	60, 108, 109	pilotone generator	8.1.
Mode 5	60, 108	pitch	
Mode 6	60, 68, 105, 110	<i>adjustment</i>	46
Mode 7	60.	<i>short pitch</i>	46
MODE-button	59, 86		
movement	42.		

PL-mount	127
power supply.....	19, 128
<i>highspeed</i>	19, 21
power supply for accessories.....	22
power supply voltage display.....	67
PowerBook	96.
PROG-button	86, 93
programmed frame rate, setting.....	65
programs, activating and running.....	93
programs, displaying.....	93
PS-Mode	66.
PS/CCU-position.....	64.

Q

quartz accuracy.....	128
quartz-synchronized monitors	67

R

R/S - socket distributor	97.
ramping	
<i>speed ramping with exposure compensation</i>	92
<i>speed ramping with the ARRIFLEX 435</i>	90
<i>with the ARRIFLEX 435</i>	90
<i>with the ARRIFLEX 435ES</i>	91
RCU-1	80, 95
remote control unit RCU-1.....	80, 95
remote run switch RS-4.....	79

reverse operation.....	66
RS 232 interface.....	80
RS-4	79.
RU-1	80.
RUN-button	58, 60, 97
<i>additional on right side</i>	97

S

S-4 shoulder set	17.
safety specifications.....	5..
screen-time for speed ramps.....	95, 96
SEL-button	59.
SET-button	59, 86
shifting phase	67.
short pitch.....	46.
shoulder cushion.....	17, 18
shoulder magazine, ARRIFLEX 35 III.....	127
shoulder operation.....	17.
shoulder operation without the shoulder set.....	18
shoulder Set S-4	
<i>with the bridge plate</i>	17
shoulder set S-4	17.
<i>without the bridge plate</i>	18
shutter angle adjustment.....	31
shutter angle display.....	64
shutter angle for HMI/CID light.....	37
shutter angle locking mechanism.....	31, 32

shutter angle locking mechanism, checking.....	35	starting	58.
shutter angle stops	31.	stopping	58.
SMPTE	101	Super 35	99.
sockets		<i>converting bridge plate</i>	100
ACC	80, 107, 109	<i>converting lens mount</i>	99
BNC-VIDEO OUT	72	support ring	14.
CCU	80, 107, 109	support rods	13.
MINI MONITOR	72	15 mm	12
MOVIE CAMERA	72	19 mm	12
VIDEO CAMERA	72	synchronization of camera to other equipment.....	81
spacer gate			
<i>cleaning</i>	118	T	
<i>installing</i>	42	take length.....	63.
<i>removing</i>	42	technical data.....	127
special forceps for ground glass.....	38, 119	tension measurement device.....	120
special tool		testing without magazine.....	30
<i>for adjusting magazine friction</i>	120	time code	101, 128
<i>for cover of video tap</i>	70	<i>acoustic warning, switching off</i>	112
speed ramping with exposure compensation.....	92	<i>buffer battery</i>	110
speed range	127	<i>buffer battery, replacing</i>	111
spiral battery cable KC 29S.....	20, 21, 22	<i>camera number</i>	106
spirit level	12.	<i>date</i>	106
standard frame rates.....	64	<i>displays</i>	112
<i>selecting</i>	65	<i>film sensitivity, setting</i>	104
standard video signal, external	8.1	<i>frame rates</i>	101
standard viewfinder system, removing.....	7.7	<i>generator</i>	106
standby	5.7.	<i>input</i>	106

loop length, checking	103	total amount of exposed film	63
LTC output	109	tripod	
LTC signal	107	<i>removing the camera from the tripod</i>	13
output	109	<i>tripod heads</i>	11
quartz accuracy	128	U	
recording, switching off	109	unit of measurement (meters/feet)	
recording, switching on	109	<i>changing on film counter</i>	63
setting	106	user bits	106
switching off	109	V	
switching on	109	video camera CCD 2-FR	69
TC user bits, displaying	108	video optic VO-2	69
TC user bits, setting with CCU-1	106	<i>adjusting</i>	72
TC-buffer	110	<i>mounting</i>	70
TC-generator	106	<i>removing</i>	70
TC-module, mounting	102	VIDEO OUT BNC-socket	72
TC-symbol	109, 112	video signal, synchronizing	69
TC-time, displaying	108	video viewfinder VT2	50, 77
TC-time, setting with CCU-1	87, 106	<i>mounting</i>	77
TC-warnings	112	video-assist-system	50, 69
TCS-value, displaying	105	AFP-2	71
TCS-value, setting	105	<i>anti-flicker processor, mounting</i>	71
TCS-value, table	104	<i>aperture of video optic, adjusting</i>	72
testing mode	109	<i>beamsplitter</i>	69
time code and ESU-1	110	<i>focus of video optic, adjusting</i>	72
time code and user bits, displaying	108	<i>image position of video optic, adjusting</i>	72
time code and user bits, setting	106	<i>mounting</i>	70
time code clock, internal	110		
warning signal, switching on and off	68		

<i>PHASE ADJ</i>	72	warnings	5..
<i>special wrench</i>	70	weight	128
<i>video camera, mounting</i>	71	Windows PC	96.
<i>white balance</i>	69	WL-3	7.8..
<i>wiring</i>	72	work light WL-3	7.8.
viewfinder arm			
<i>extending</i>	52		
<i>setting friction</i>	52		
<i>swivelling</i>	52		
<i>turning the eyepiece</i>	52		
viewfinder friction	52		
viewfinder system.....	50, 128		
<i>adjusting</i>	52		
<i>attaching</i>	55		
<i>displays in viewfinder</i>	50		
<i>exchanging</i>	55		
<i>removing</i>	55		
voltage of TC bufer battery	110		
voltage range	19, 128		
VT-2	77..		

W

warning display module.....	54
warning displays	61, 62, 123
warning signal	
<i>settings</i>	68
<i>switching on and off</i>	68
<i>volume</i>	68

ARRI Service

Germany Arnold & Richter Cine Technik
Türkenstraße 89
D-80799 München
phone: (089) 3809-0
fax: (089) 3809-1244
fax service: (089) 3809-1793
E-mail service: KDenk@arri.de

USA ARRI USA
617, Route 303
Blauvelt, New York 10913
phone: (914) 353 14 00
fax: (914) 425 12 50
E-mail: arriflex@arri.com

ARRI USA
600 North Victory Blvd.
Burbank, California 91502
phone: (818) 841 70 70
fax: (818) 848 40 28
E-mail: arriflex@arri.com

GB ARRI (GB) Ltd.
The Movie House
1-3 Airlinks, Spitfire Way
phone: (0208) 848 88 81
fax: (0208) 561 13 12
E-mail: sales@arri-gb.com

Italy ARRI ITALIA S.R.L.
Viale Edison 318
20099 Sesto S. Giovanni (Milano)
phone: (02) 26 22 71 75
fax: (02) 242 16 92
E-mail: info@arri.it

ARRI ITALIA S.R.L.
Via Placanica, 97
00040 Morena (Roma)
phone: (06) 79 89 02 02
fax: (06) 79 89 02 39

Canada ARRI Canada Ltd.
415 Horner Avenue, Unit 11
Etobicoke, Ontario
Canada M8W 4W3
phone: (416) 255 33 35
fax: (416) 255 33 99
E-mail: service@arrican.com

Technical data are subject to change without notice
Printed in Germany

Ident Nr. 09.91924.0